

VITA

VI 00055 4

VI 00056 4

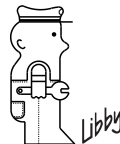

cisal
RUBINETTERIA

1

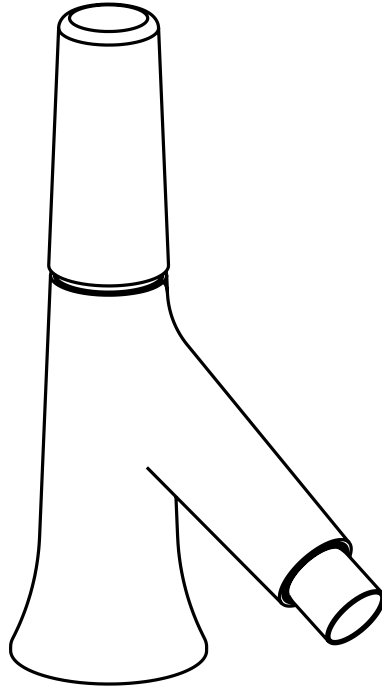

VI 00055 4

VI 00056 4

Fabbricato in Italia - Made in Italy

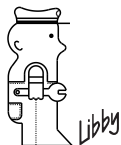

cisal
RUBINETTERIA

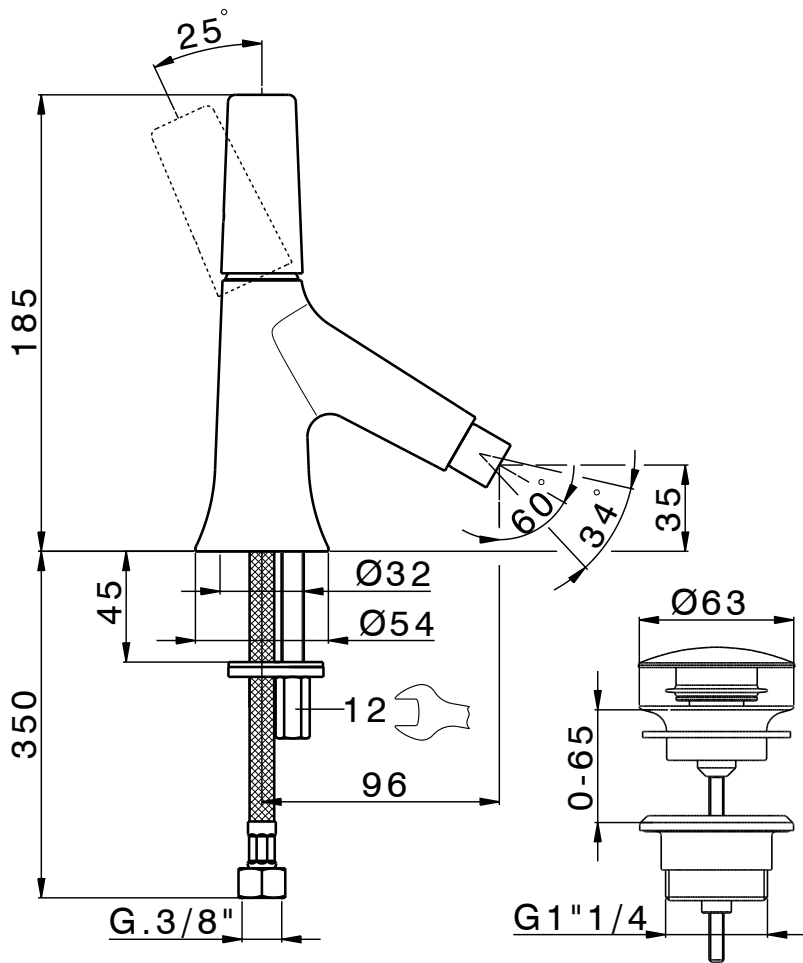

ATTENZIONE: Consegnare queste istruzioni all'utilizzatore e conservarle.

WARNING: Please leave these instructions with the user and keep them.

ATTENTION: Remettre ces instructions à l'utilisateur et les conserver.

ACHTUNG: Geben Sie bitte dem Käufer der Armatur diese Anweisungen zur Aufbewahrung.

ATENCIÓN: Entregar estas instrucciones al usuario y conservarlas.

OPGELET: Bij de levering van kraanwerk, gelieve de gebruiksvoorwaarden en Onderhouds-methoden mee te leveren.

I CONDIZIONI DI ESERCIZIO

- Pressione dinamica minima.....1 bar
- Pressione di esercizio raccomandata (statica).....3 bar
(ATTENZIONE: per pressioni superiori a 5 bar si raccomanda di installare un riduttore di pressione)
- Pressione massima di esercizio (statica).....5 bar
- Pressione massima di prova (statica).....16 bar
- Temperatura massima acqua calda.....80 °C
- Temperatura raccomandata acqua calda.....65 °C (per sicurezza e risparmio energetico)

GB OPERATING CONDITIONS

- Minimum dynamic pressure.....1 bar
- Recommended working pressure (static).....3 bar
(ATTENTION: when pressure exceeds 5 bar, the installation of a pressure reducer is recommended)
- Maximum working pressure (static).....5 bar
- Maximum test pressure (static).....16 bar
- Maximum hot water temperature.....80 °C
- Recommended hot water temperature.....65 °C (for safety and energy saving)

F CONDITIONS DE SERVICE

- Pression dynamique minimum1 bar
- Pression de service recommandée (statique).....3 bar
(En cas de pression supérieure à 5 bar il est recommandé d'installer un réducteur de pression)
- Pression de service maximum (statique).....5 bar
- Pression maximum de test (statique).....16 bar
- Température maximum eau chaude80 °C
- Température recommandée eau chaude.....65 °C (pour sécurité et économie d'énergie)

D TECHNISCHE DATEN

- Minimaler dynamischer Druck1 bar
- Empfohlener Betriebsdruck (statisch)3 bar
(Bei mehr als 5 bar ist der Einbau eines Druckverminderers unerlässlich)
- Maximaler Betriebsdruck (statisch).....5 bar
- Maximaler Prüfdruck (statisch).....16 bar
- Maximale Warmwassertemperatur.....80 °C
- Empfohlene Warmwassertemperatur65 °C (zur Energieeinsparung)

E DATOS TÉCNICOS

- Presión dinámica mínima.....1 bar
- Presión de trabajo recomendada (estática).....3 bar
(N.B.: para presiones superiores a los 5 bar les recomendamos instalar un reductor de presión)
- Presión máxima de trabajo (estática).....5 bar
- Presión máxima de prueba (estática).....16 bar
- Temperatura máxima agua caliente.....80 °C
- Temperatura recomendada agua caliente65 °C (para ahorrar energía)

NL TECHNISCHE GEGEVENS

- Minimum dynamische druk1 bar
- Aanbevolen bedrijfsdruk (statisch)3 bar
(N.B: in geval van druk, hoger dan 5 bar, raden wij u aan een drukvermindingsklep te installeren)
- Maximum bedrijfsdruk (statisch).....5 bar
- Maximum proefdruk (statisch).....16 bar
- Maximum warmwatertemperatuur.....80 °C
- Aanbevolen warmwatertemperatuur65 °C (voor energiebesparing)



Non incluso / Not included / Non inclus / Nicht Dabei / No incluido / Nitinbegrepen



Incluso / Included / Inclus / Dabei / incluido / Inbegrepen

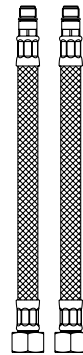
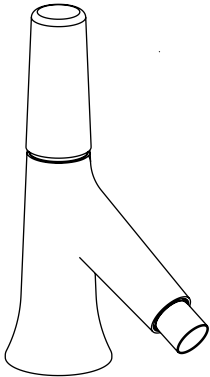

B1



C1



C2

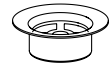

C3



C4



C5



C6



A1



A2



A3



A4



A5

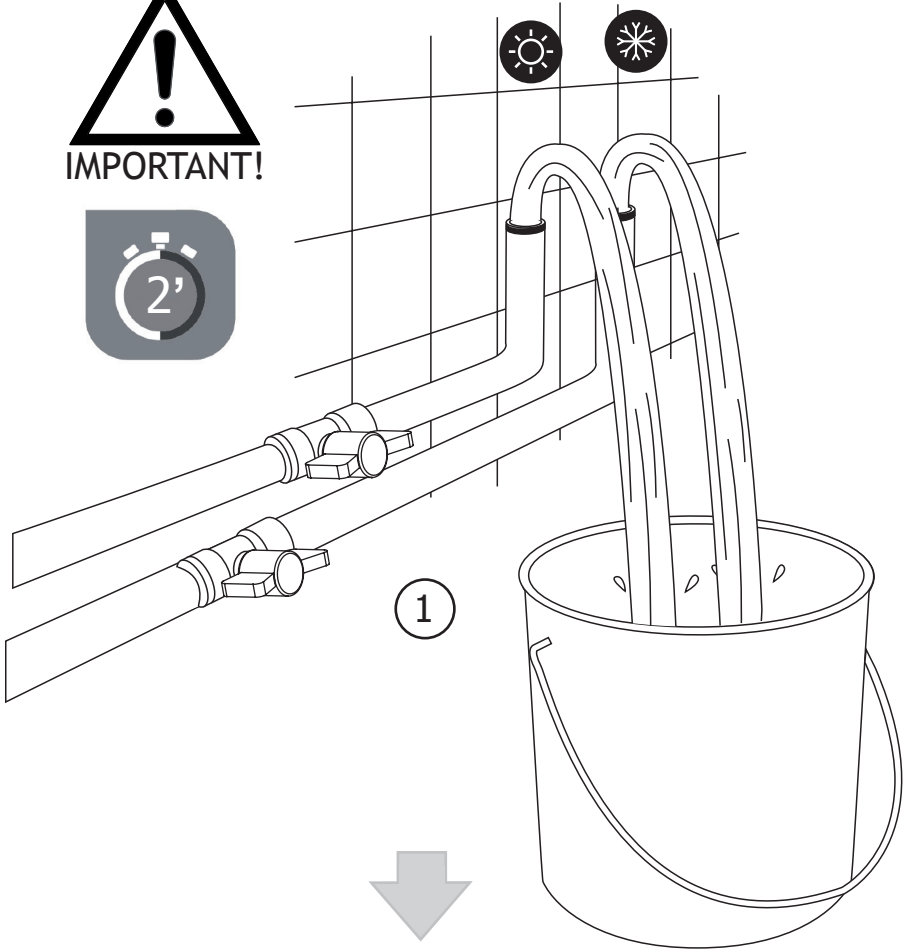

2

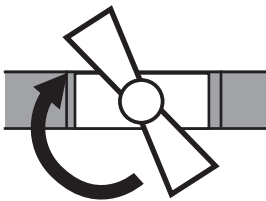

6

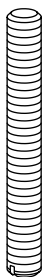
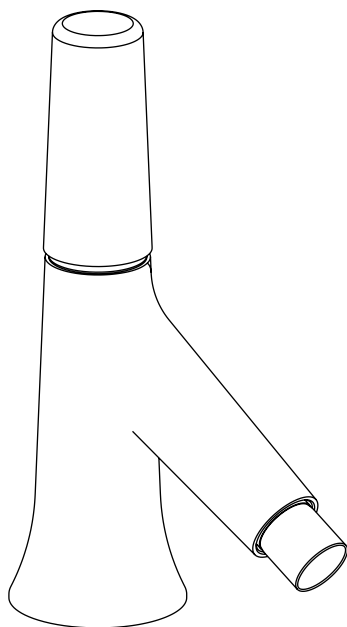
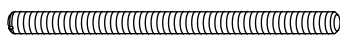
**A1****A1**

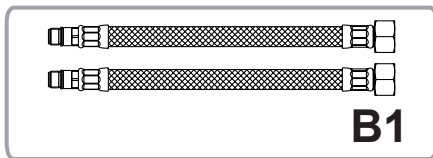
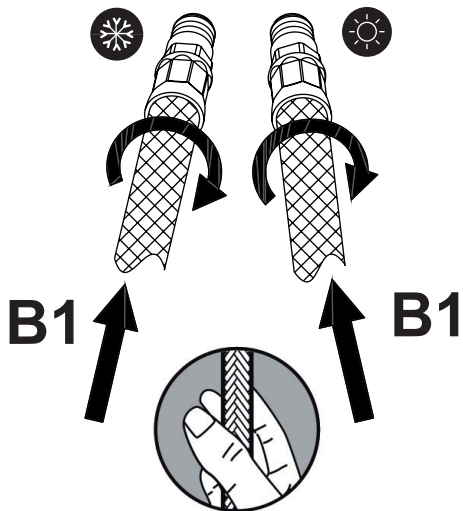
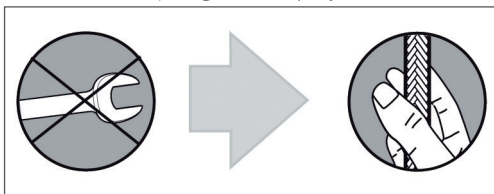
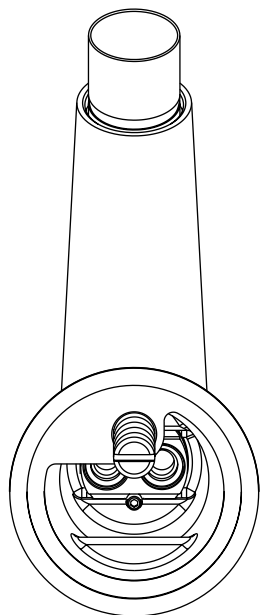

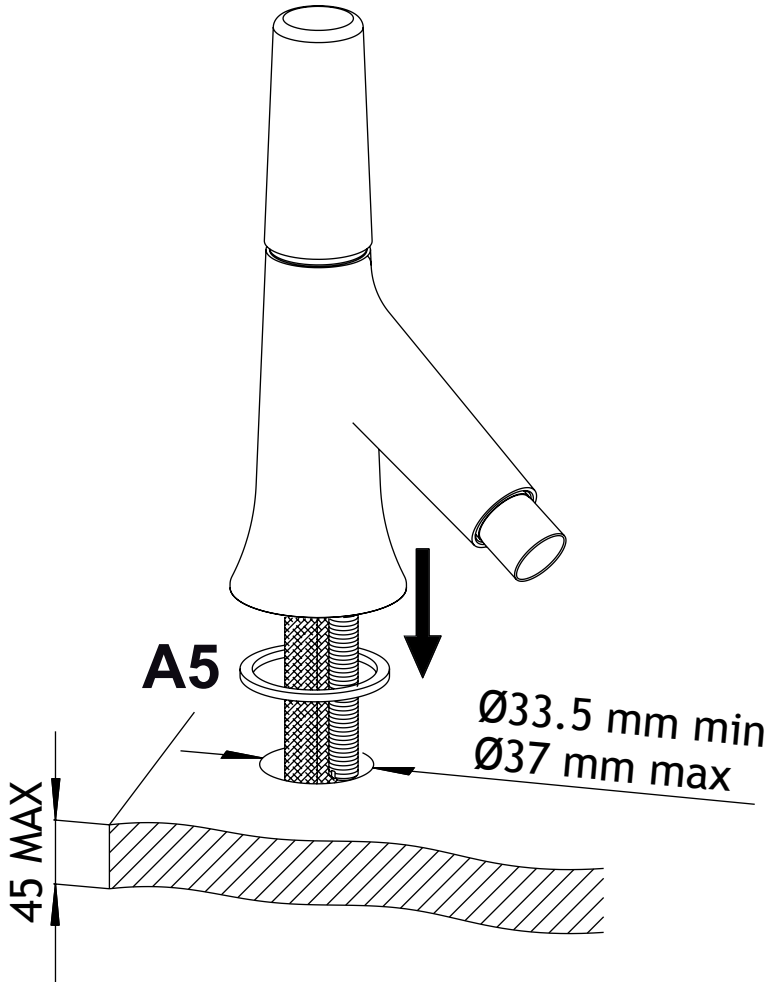
**A5**

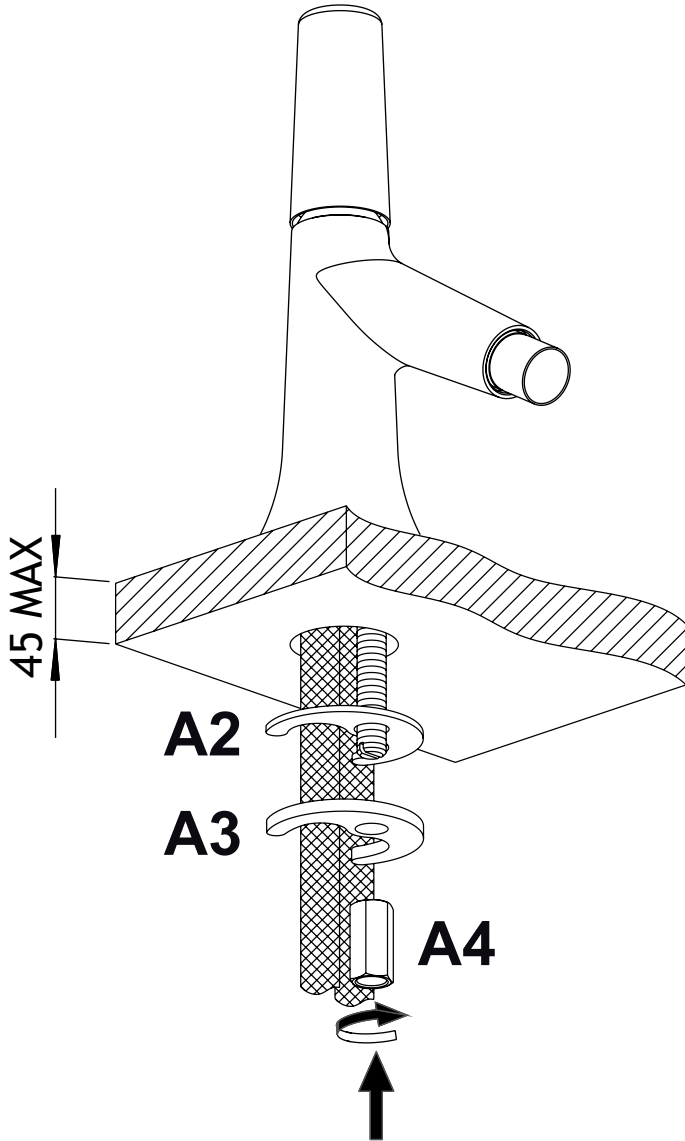

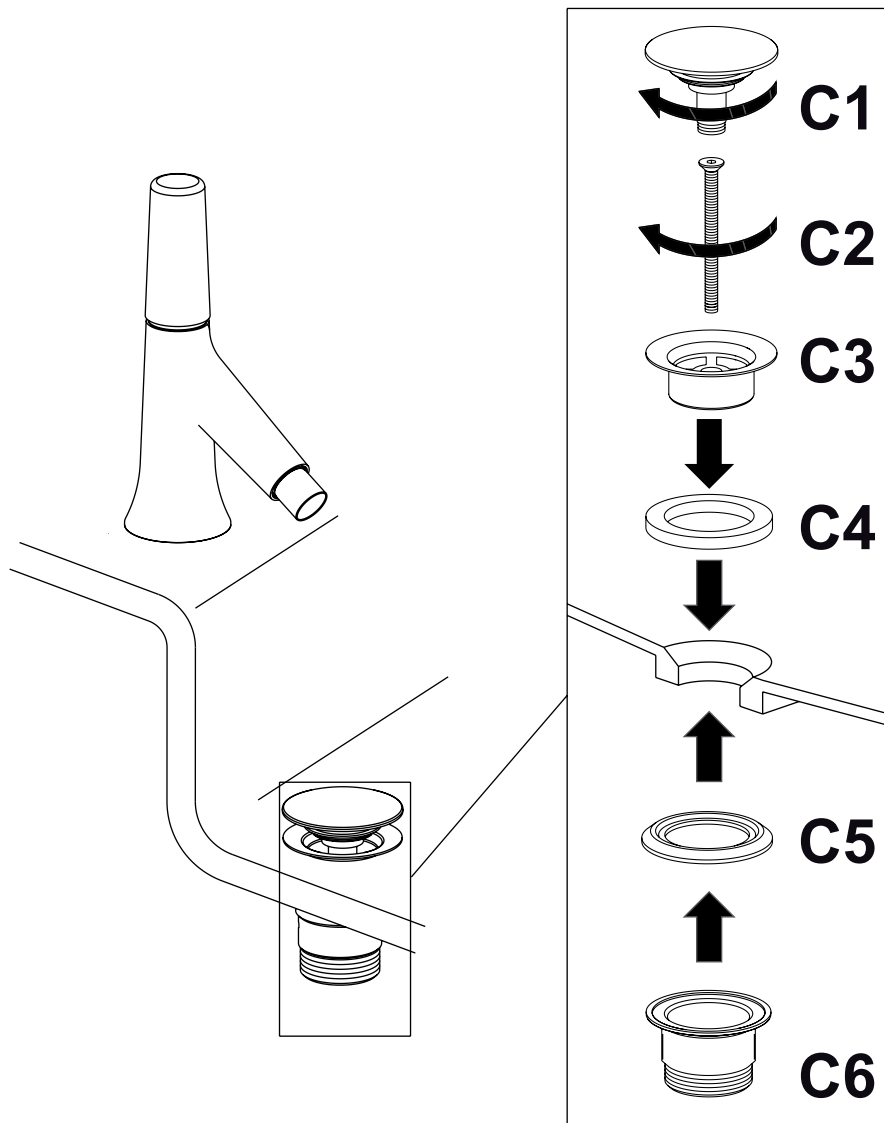

C6



C5

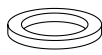

C4



C3



C2



C1

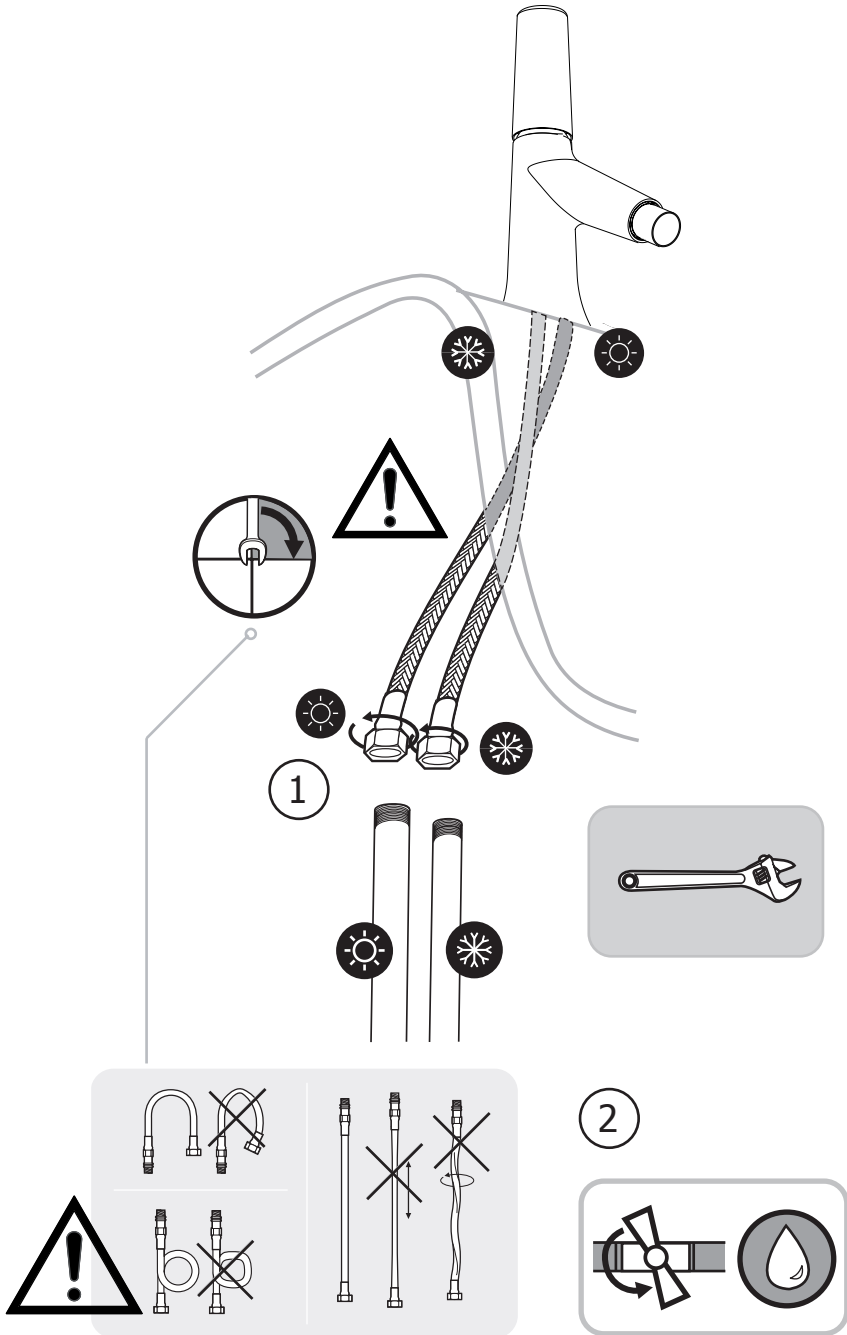

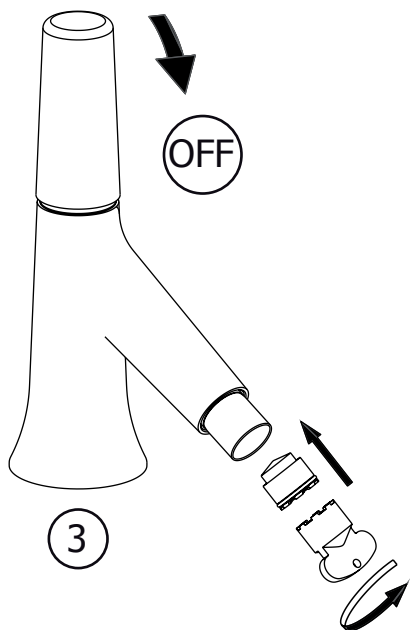
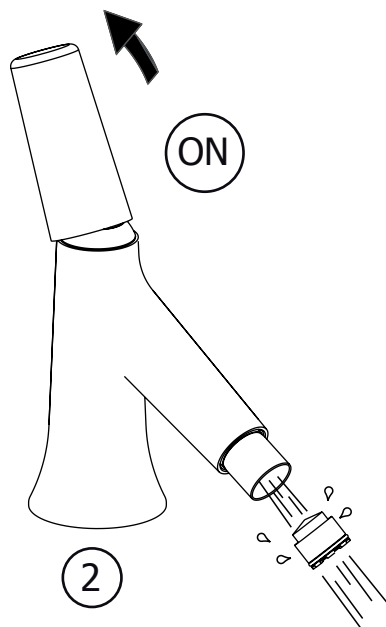
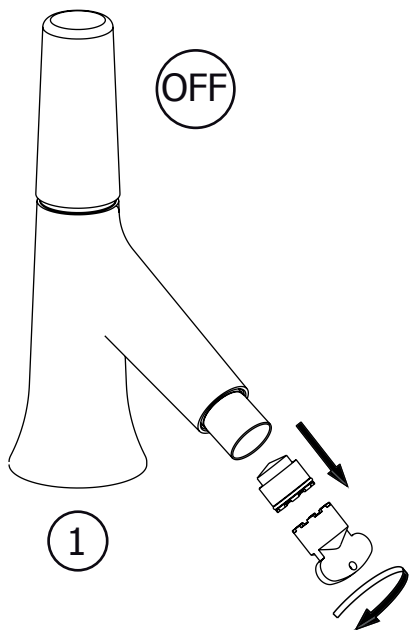

Non incluso / Not included / Non inclus / Nicht Dabei / No incluido / Nitinbegrepen

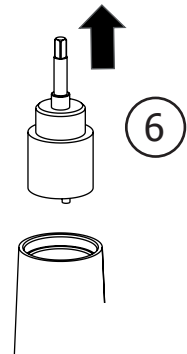
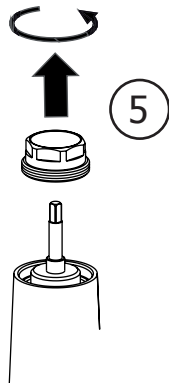
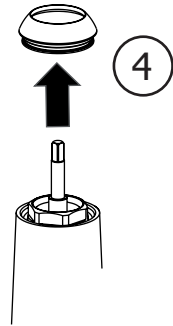
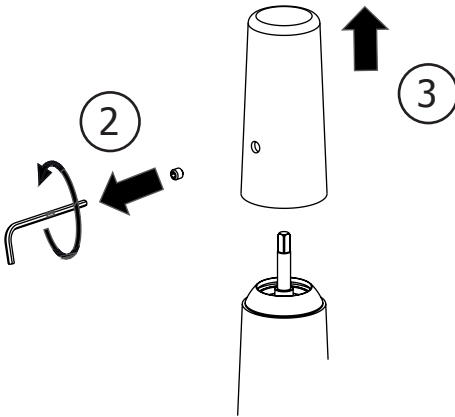
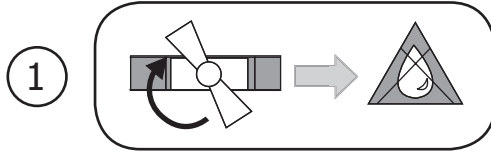
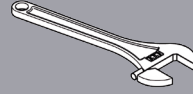
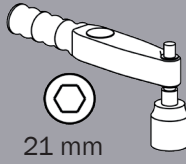

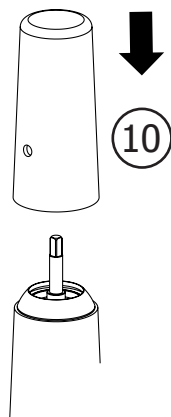
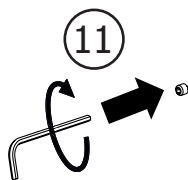
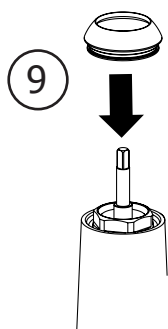
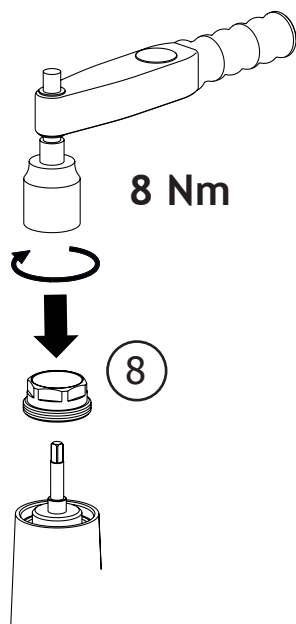
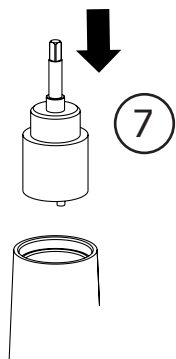

12

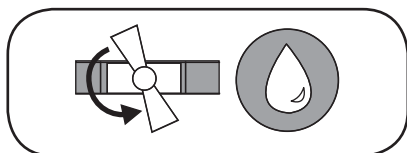

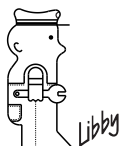
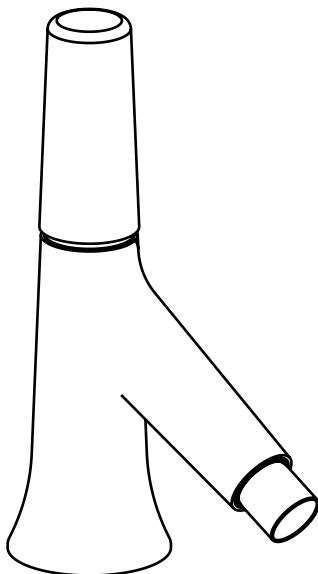

cisal
RUBINETTERIA

CISAL

Via Pietro Durio, 160
28010 Alzo di Pella (Novara) - Italia
Tel. +39.0322.918111
Fax +39.0322.969518
E-Mail: cisal@cisal.it
- www.cisal.it -

ATTENZIONE: Consegnare queste istruzioni all'utente e conservarle.

WARNING: Please leave these instructions with the user and keep them.

ATTENTION: Remettre ces instructions à l'utilisateur et les conserver.

ACHTUNG: Geben Sie bitte dem Käufer der Armatur diese Anweisungen zur Aufbewahrung.

ATENCION: Entregar estas instrucciones al usuario y conservarlas.

OPGELET: Bij de levering van kraanwerk, gelieve de gebruiksvoorwaarden en Onderhouds-methoden mee te leveren.