

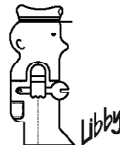

**VITA**  
**VI 00010 4**



**cisal**  
RUBINETTERIA



**VI 00010 4**

**Fabbricato in Italia - Made in Italy**

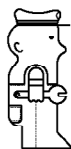

**cisal**  
RUBINETTERIA

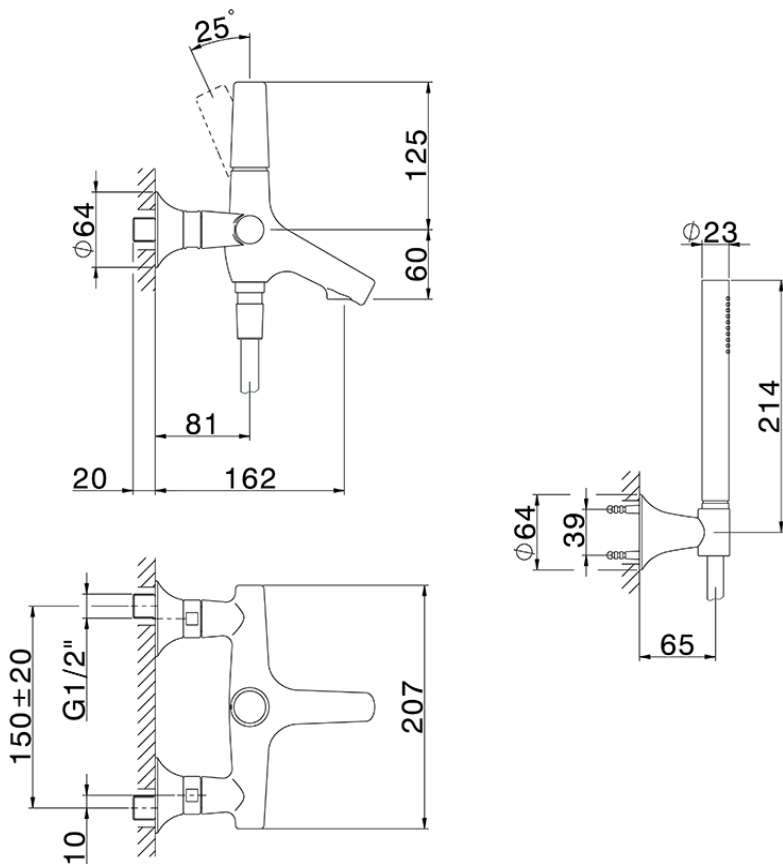

**ATTENZIONE:** Consegnare queste istruzioni all'utilizzatore e conservarle.

**WARNING:** Please leave these instructions with the user and keep them.

**ATTENTION:** Remettre ces instructions à l'utilisateur et les conserver.

**ACHTUNG:** Geben Sie bitte dem Käufer der Armatur diese Anweisungen zur Aufbewahrung.

**ATENCIÓN:** Entregar estas instrucciones al usuario y conservarlas.

**OPGELET:** Bij de levering van kraanwerk, gelieve de gebruiksvoorwaarden en Onderhouds-methoden mee te leveren.

**I** CONDIZIONI DI ESERCIZIO

- Pressione dinamica minima.....1 bar
- Pressione di esercizio raccomandata (statica).....3 bar  
(ATTENZIONE: per pressioni superiori a 5 bar si raccomanda di installare un riduttore di pressione)
- Pressione massima di esercizio (statica).....5 bar
- Pressione massima di prova (statica).....16 bar
- Temperatura massima acqua calda.....80 °C
- Temperatura raccomandata acqua calda.....65 °C (per sicurezza e risparmio energetico)

**GB** OPERATING CONDITIONS

- Minimum dynamic pressure.....1 bar
- Recommended working pressure (static).....3 bar  
(ATTENTION: when pressure exceeds 5 bar, the installation of a pressure reducer is recommended)
- Maximum working pressure (static).....5 bar
- Maximum test pressure (static).....16 bar
- Maximum hot water temperature.....80 °C
- Recommended hot water temperature.....65 °C (for safety and energy saving)

**F** CONDITIONS DE SERVICE

- Pression dynamique minimum .....1 bar
- Pression de service recommandée (statique).....3 bar  
(En cas de pression supérieure à 5 bar il est recommandé d'installer un réducteur de pression)
- Pression de service maximum (statique).....5 bar
- Pression maximum de test (statique).....16 bar
- Température maximum eau chaude .....80 °C
- Température recommandée eau chaude.....65 °C (pour sécurité et économie d'énergie)

**D** TECHNISCHE DATEN

- Minimaler dynamischer Druck .....1 bar
- Empfohlener Betriebsdruck (statisch) .....3 bar  
(Bei mehr als 5 bar ist der Einbau eines Druckverminderers unerlässlich)
- Maximaler Betriebsdruck (statisch).....5 bar
- Maximaler Prüfdruck (statisch).....16 bar
- Maximale Warmwassertemperatur.....80 °C
- Empfohlene Warmwassertemperatur .....65 °C (zur Energieeinsparung)

**E** DATOS TÉCNICOS

- Presión dinámica mínima.....1 bar
- Presión de trabajo recomendada (estática).....3 bar  
(N.B.: para presiones superiores a los 5 bar les recomendamos instalar un reductor de presión)
- Presión máxima de trabajo (estática).....5 bar
- Presión máxima de prueba (estática).....16 bar
- Temperatura máxima agua caliente.....80 °C
- Temperatura recomendada agua caliente .....65 °C (para ahorrar energía)

**NL** TECHNISCHE GEGEVENS

- Minimum dynamische druk .....1 bar
- Aanbevolen bedrijfsdruk (statisch) .....3 bar  
(N.B: in geval van druk, hoger dan 5 bar, raden wij u aan een drukverminderingsklep te installeren)
- Maximum bedrijfsdruk (statisch).....5 bar
- Maximum proefdruk (statisch).....16 bar
- Maximum warmwatertemperatuur.....80 °C
- Aanbevolen warmwatertemperatuur .....65 °C (voor energiebesparing)

30'

Non incluso / Not included / Non inclus / Nicht Dabei / No incluido / Nitinbegrepen

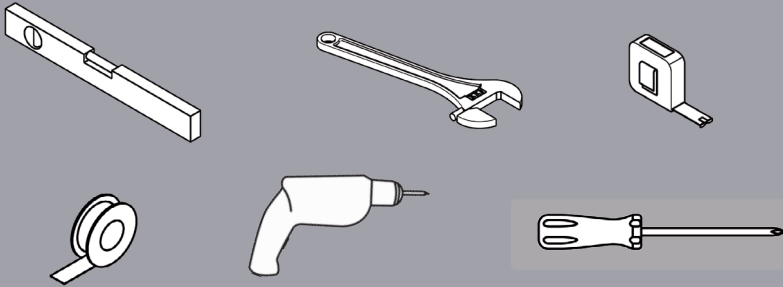

Incluso / Included / Inclus / Dabei / incluido / Inbegrepen

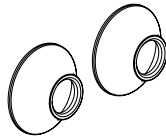
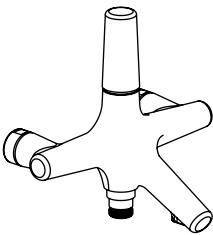
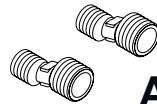
**A1****A3****A2****D****B1****B3****B5**

3mm

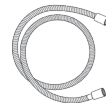
**B2****B4****C2****C1**

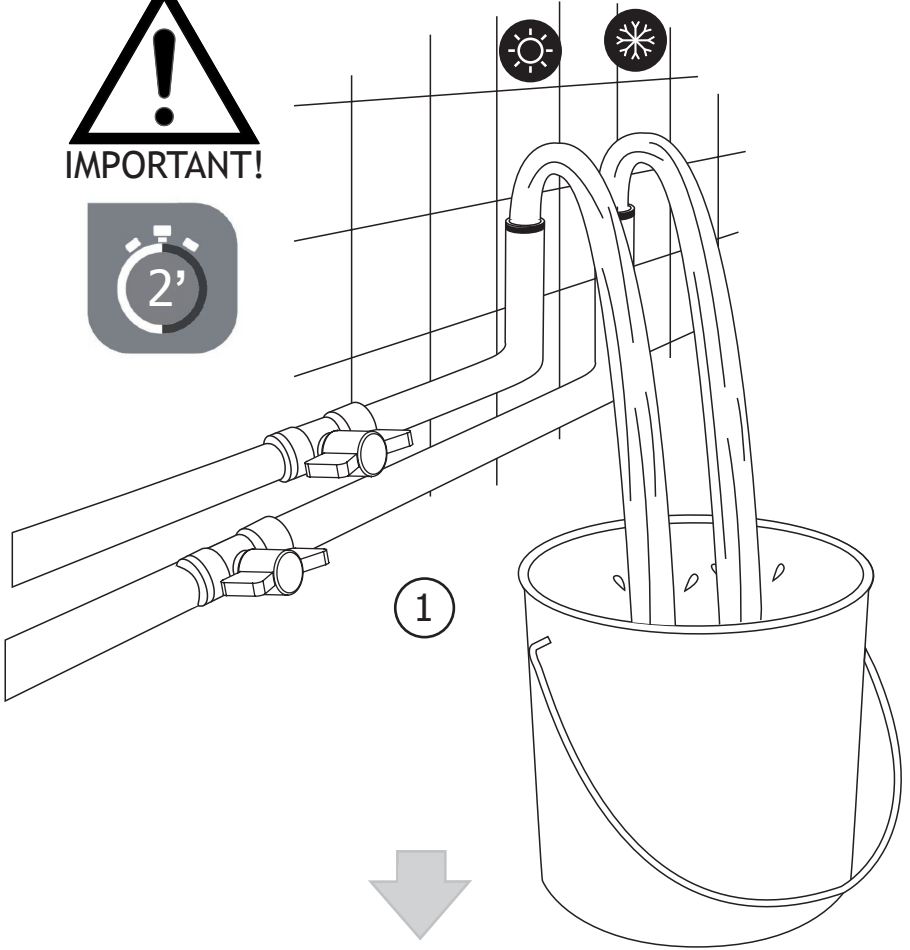

2

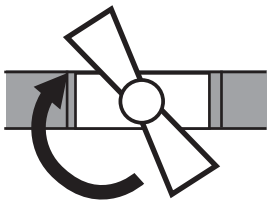

6

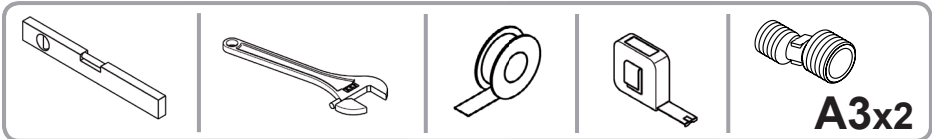
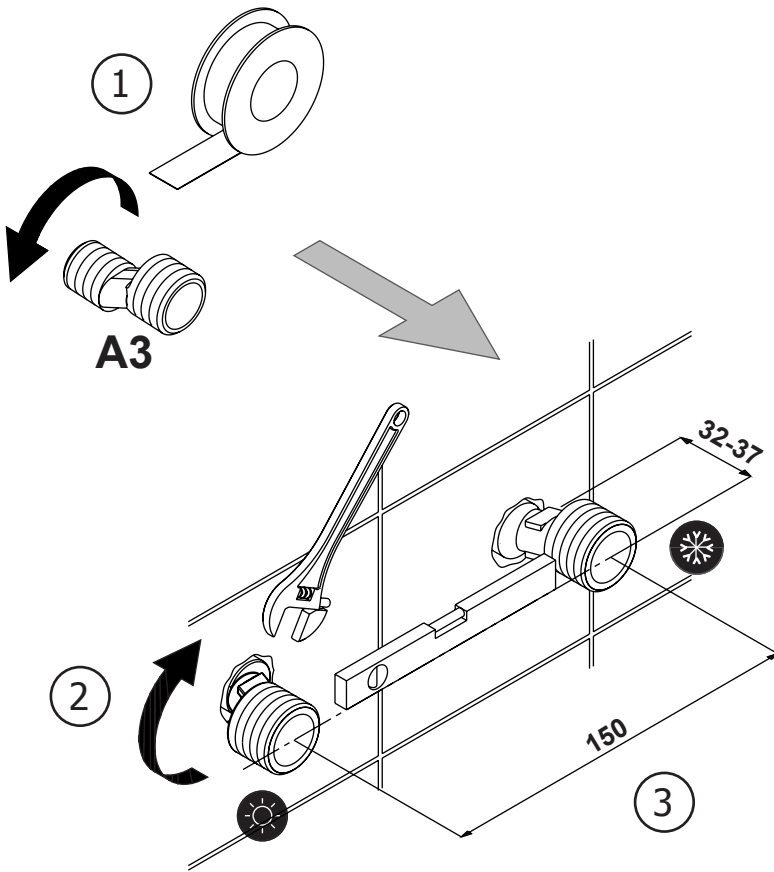

7

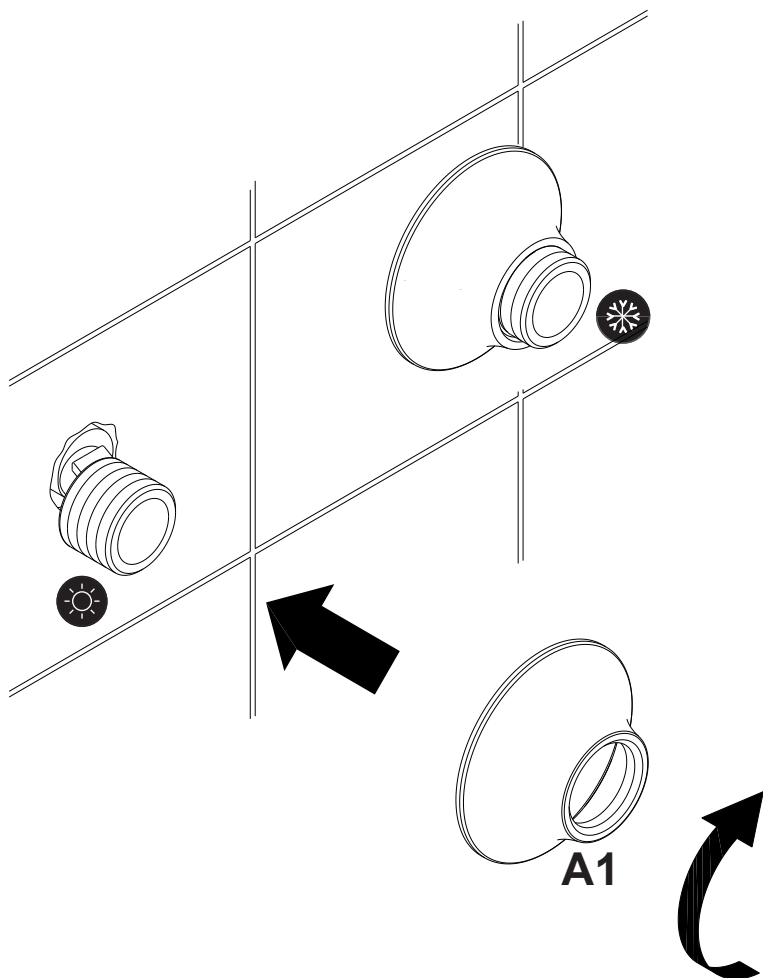

A1x2



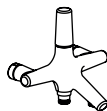
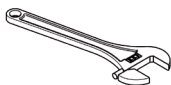
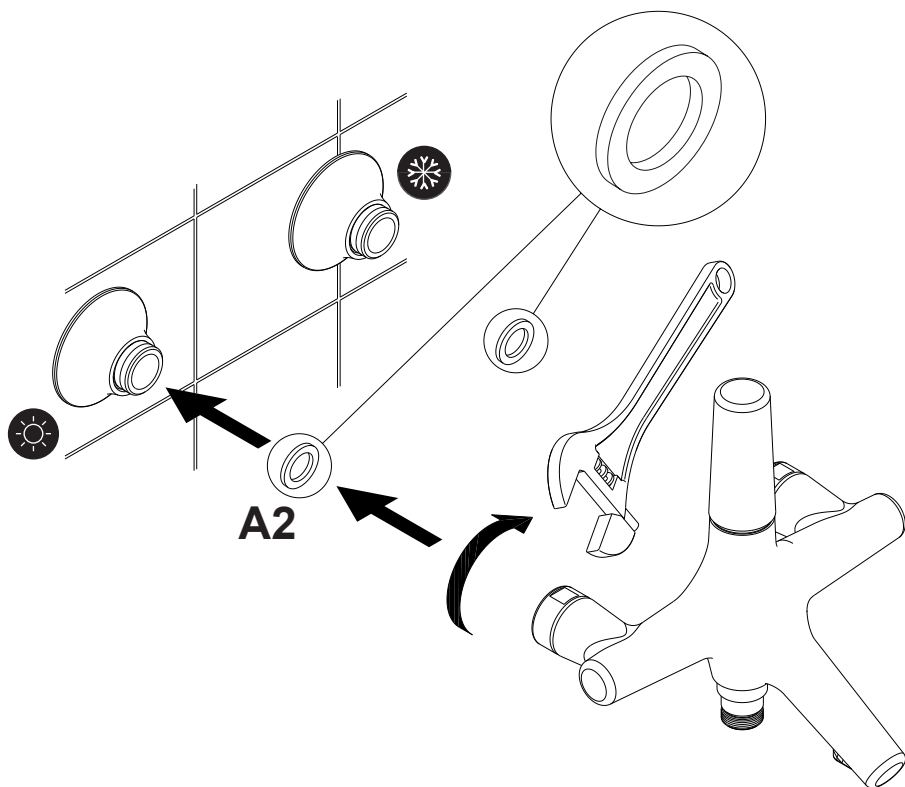

**A2x2**

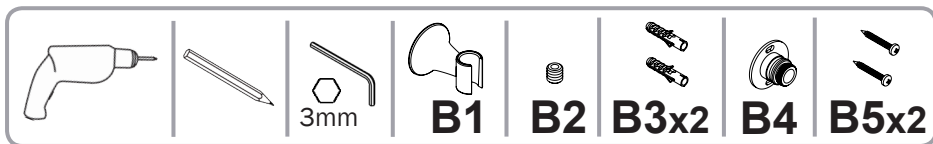
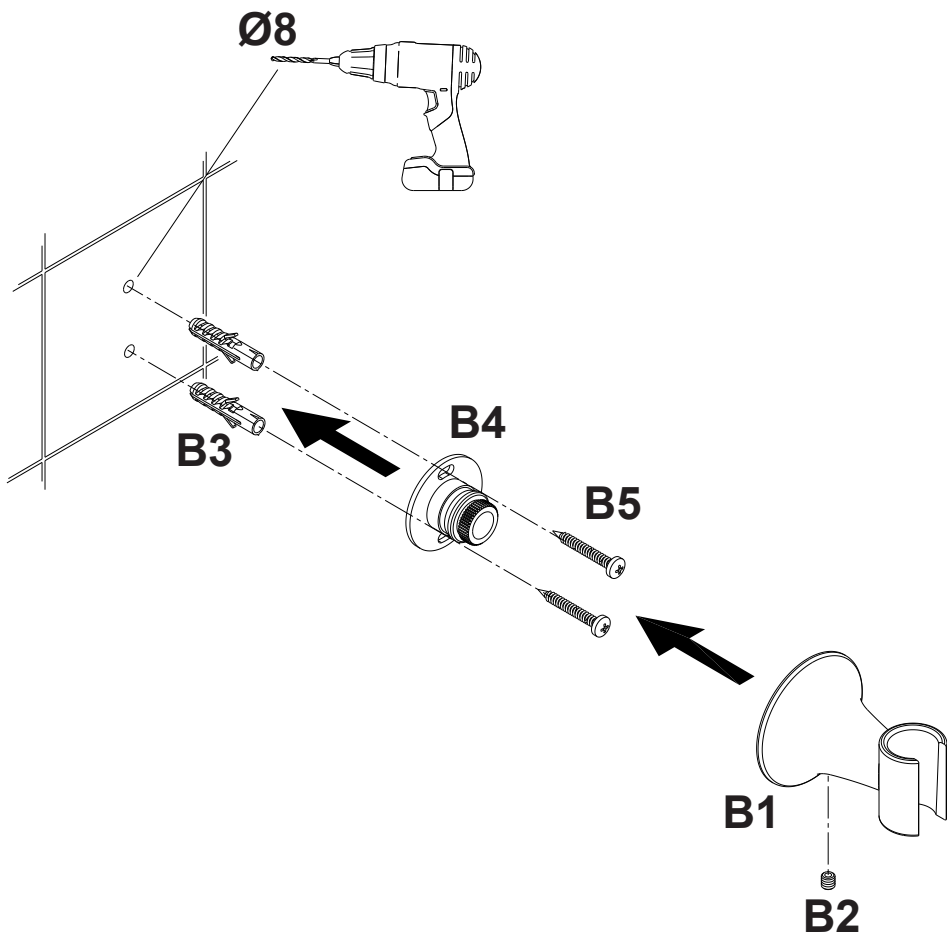

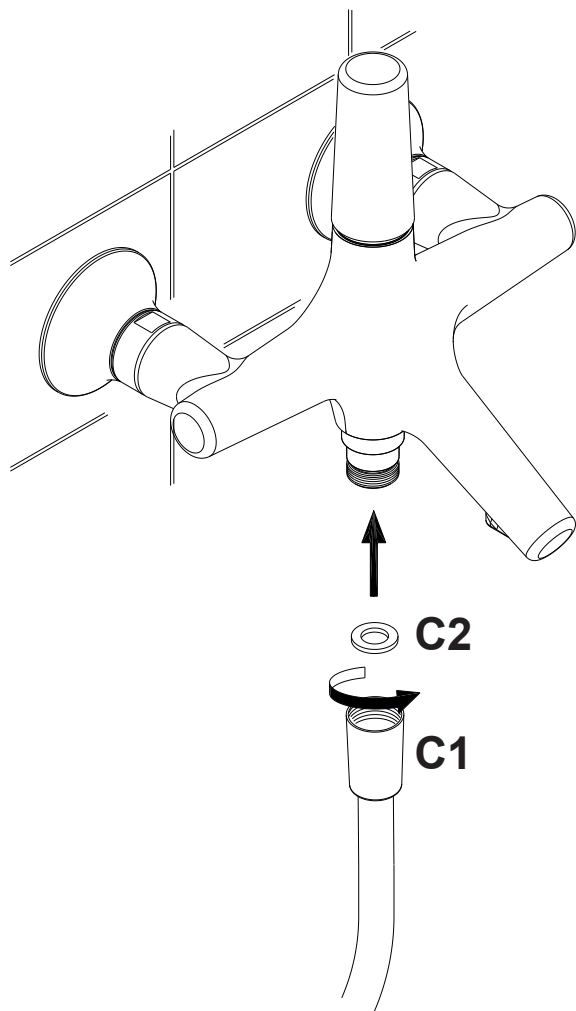
**C2****C1**

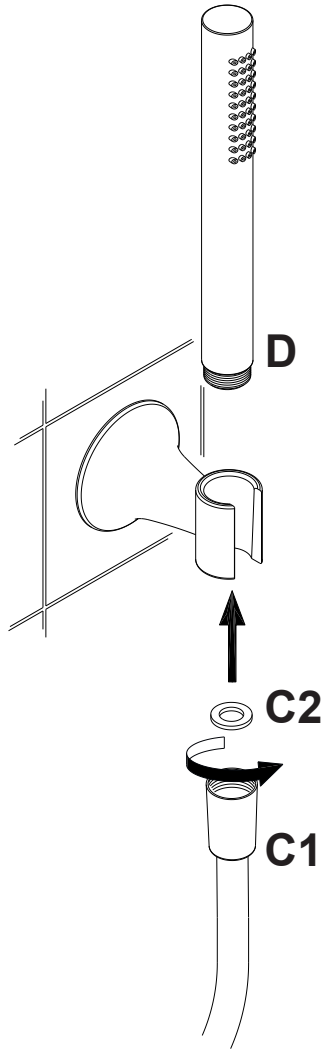
**D****C2****C1**

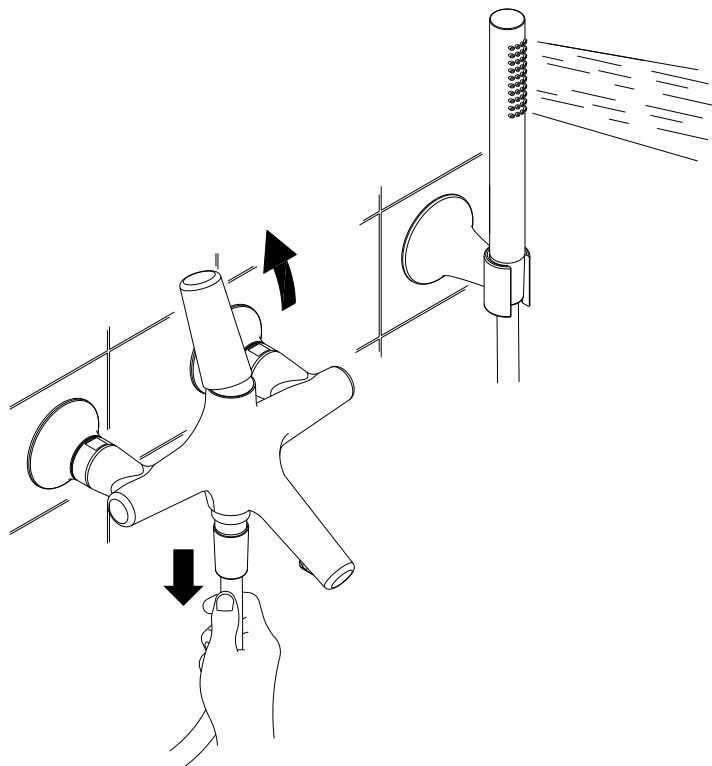
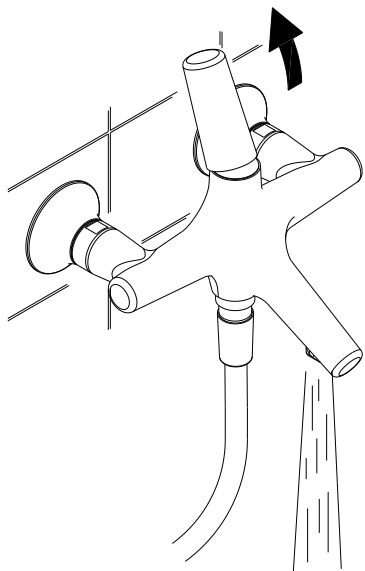

Non incluso / Not included / Non inclus / Nicht Dabei / No incluido / Nitinbegrepen

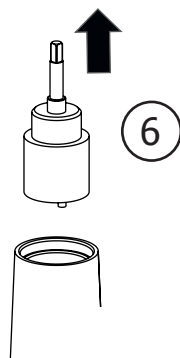
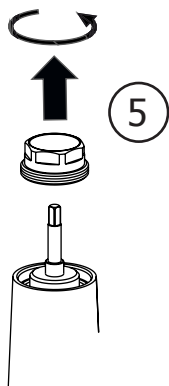
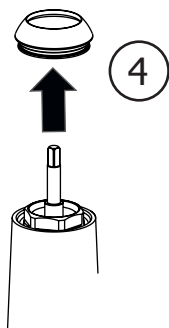
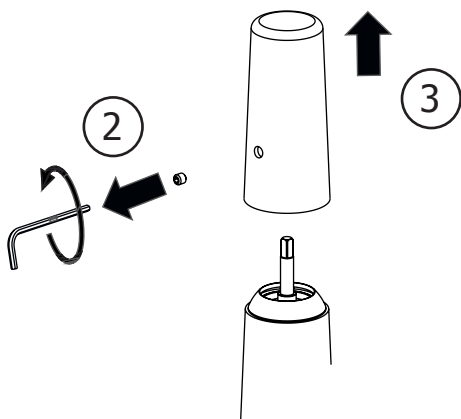
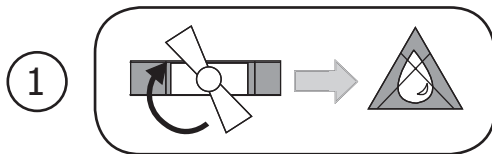
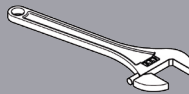
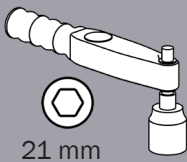

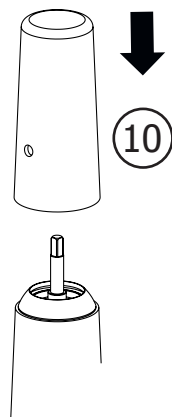
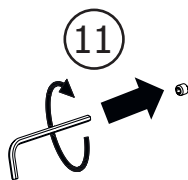
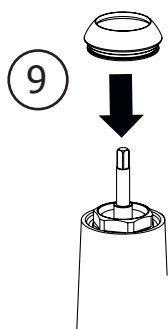
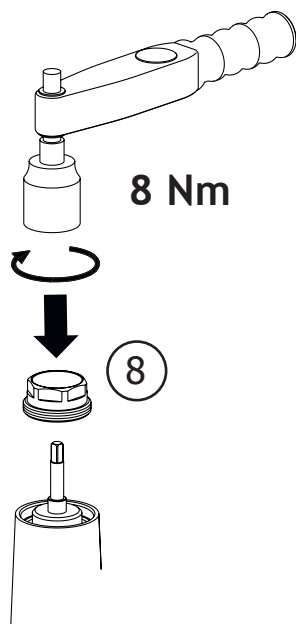
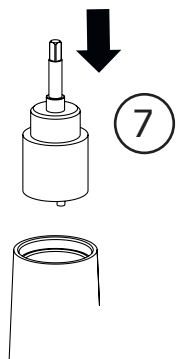

12

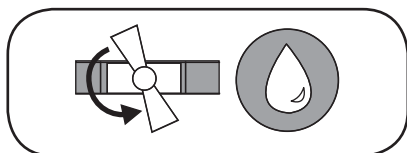

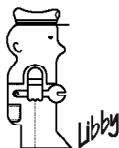

**cisal**  
RUBINETTERIA

**CISAL**

Via Pietro Durio, 160  
28010 Alzo di Pella (Novara) - Italia  
Tel. +39.0322.918111  
Fax +39.0322.969518  
E-Mail: [cisal@cisal.it](mailto:cisal@cisal.it)  
- [www.cisal.it](http://www.cisal.it) -

---

**ATTENZIONE:** Consegnare queste istruzioni all'utilizzatore e conservarle.

**WARNING:** Please leave these instructions with the user and keep them.

**ATTENTION:** Remettre ces instructions à l'utilisateur et les conserver.

**ACHTUNG:** Geben Sie bitte dem Käufer der Armatur diese Anweisungen zur Aufbewahrung.

**ATENCION:** Entregar estas instrucciones al usuario y conservarlas.

**OPGELET:** Bij de levering van kraanwerk, gelieve de gebruiksvoorwaarden en Onderhouds-methoden mee te leveren.