

Exposed part for con.thermo.shower valve 1-outlet SMOOTH X32_X3007300

MODEL **X3007300**

Exposed part for con.thermo.shower valve 1-outlet, stop valve, without concealed part, for items ZA007301, with smooth handles - Inox AISI 316L

AVAILABLE FINISHINGS

-  **D1** D1 Brushed Inox
-  **5H** 5H Dark Brass Brushed
-  **5L** 5L Brushed Black Titanium
-  **5N** 5N Brushed Rose Gold

CHARACTERISTICS

Installation **Concealed**
 Required concealed parts **ZA007301**

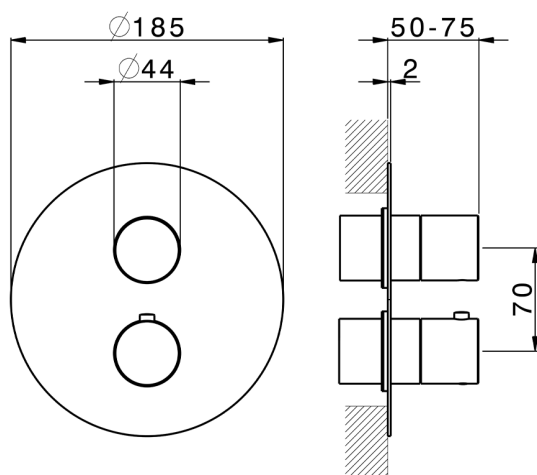
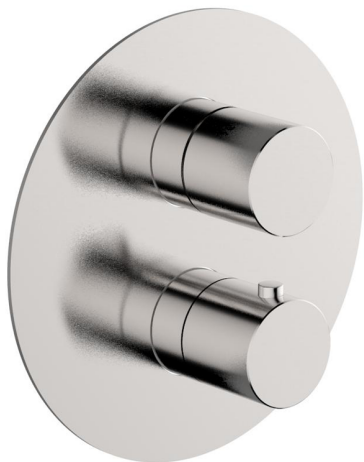

Thermostatic

The Cisal thermostatic is your personal water manager, helping you to handle, control and save water and energy.



Exposed part for con.thermo.shower valve 1-outlet SMOOTH X32_X3007300

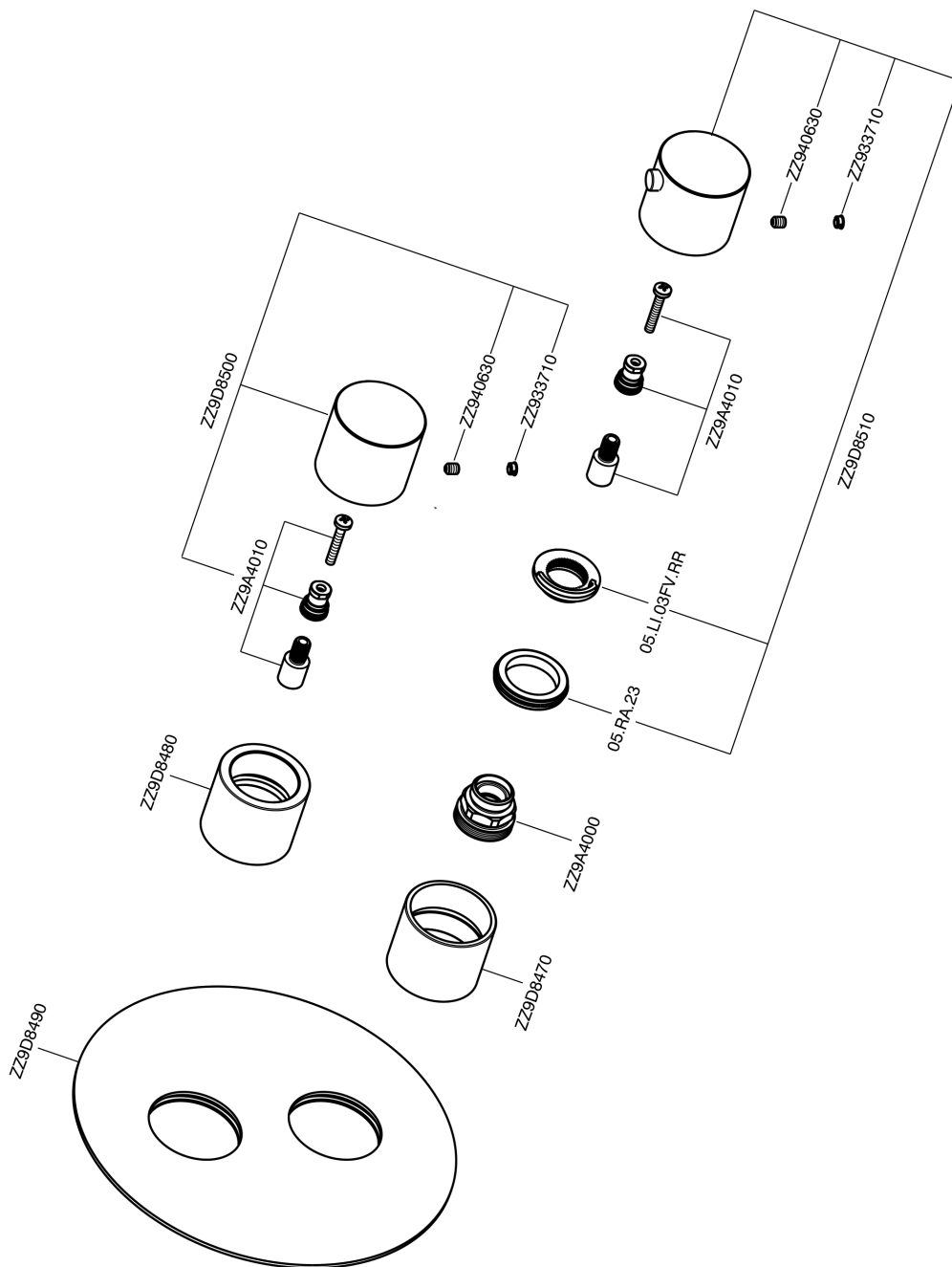

X3007300

<https://en.cisal.it/exposed-part-for-con-thermo-shower-valve-1-outlet-smooth-x32-x3007300>

Concealed thermostatic shower valve, 1-outlet CONCEALED_ZA007301

MODEL **ZA007301**

Concealed thermostatic shower valve,
1-outlet, Stopvalve with 1/2" outlet, without trim kit



AVAILABLE FINISHINGS



CHARACTERISTICS

Concealed **1**
Cartridge Spare Parts **24.04A.PP**
8x20 Plus P Thermostatic Valve

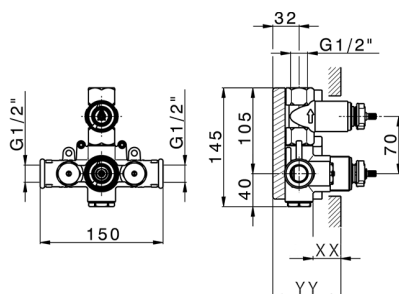

Piastra/Plate/Plaque/Platte/Placa
2-3mm: XX 25-40 YY 76-91
10mm: XX 16-31 YY 65-80



Thermostatic

The Cisal thermostatic is your personal water manager, helping you to handle, control and save water and energy.



2026-06-08