

## Exposed part for con.thermo.shower valve 1-outlet SMOOTH X32\_X3007300

MODEL **X3007300**

Exposed part for con.thermo.shower valve 1-outlet, stop valve, without concealed part, for items ZA007301, with smooth handles - Inox AISI 316L

### AVAILABLE FINISHINGS

-  **D1** D1 Brushed Inox
-  **5H** 5H Dark Brass Brushed
-  **5L** 5L Brushed Black Titanium
-  **5N** 5N Brushed Rose Gold

### CHARACTERISTICS

Installation **Concealed**  
 Required concealed parts **ZA007301**

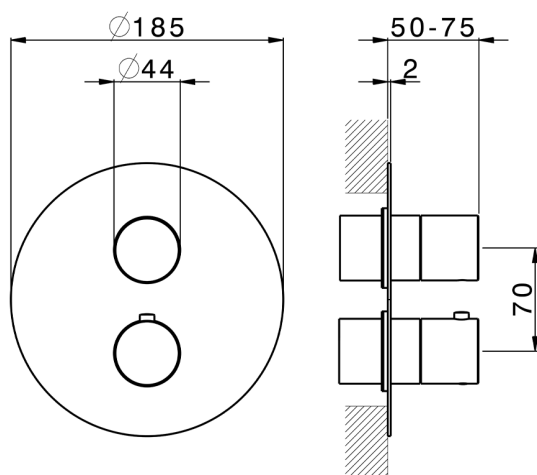
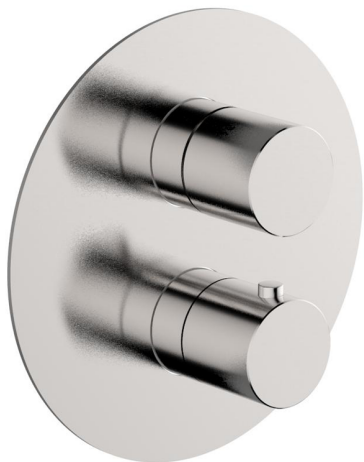

### Thermostatic

The Cisal thermostatic is your personal water manager, helping you to handle, control and save water and energy.



## Exposed part for con.thermo.shower valve 1-outlet SMOOTH X32\_X3007300

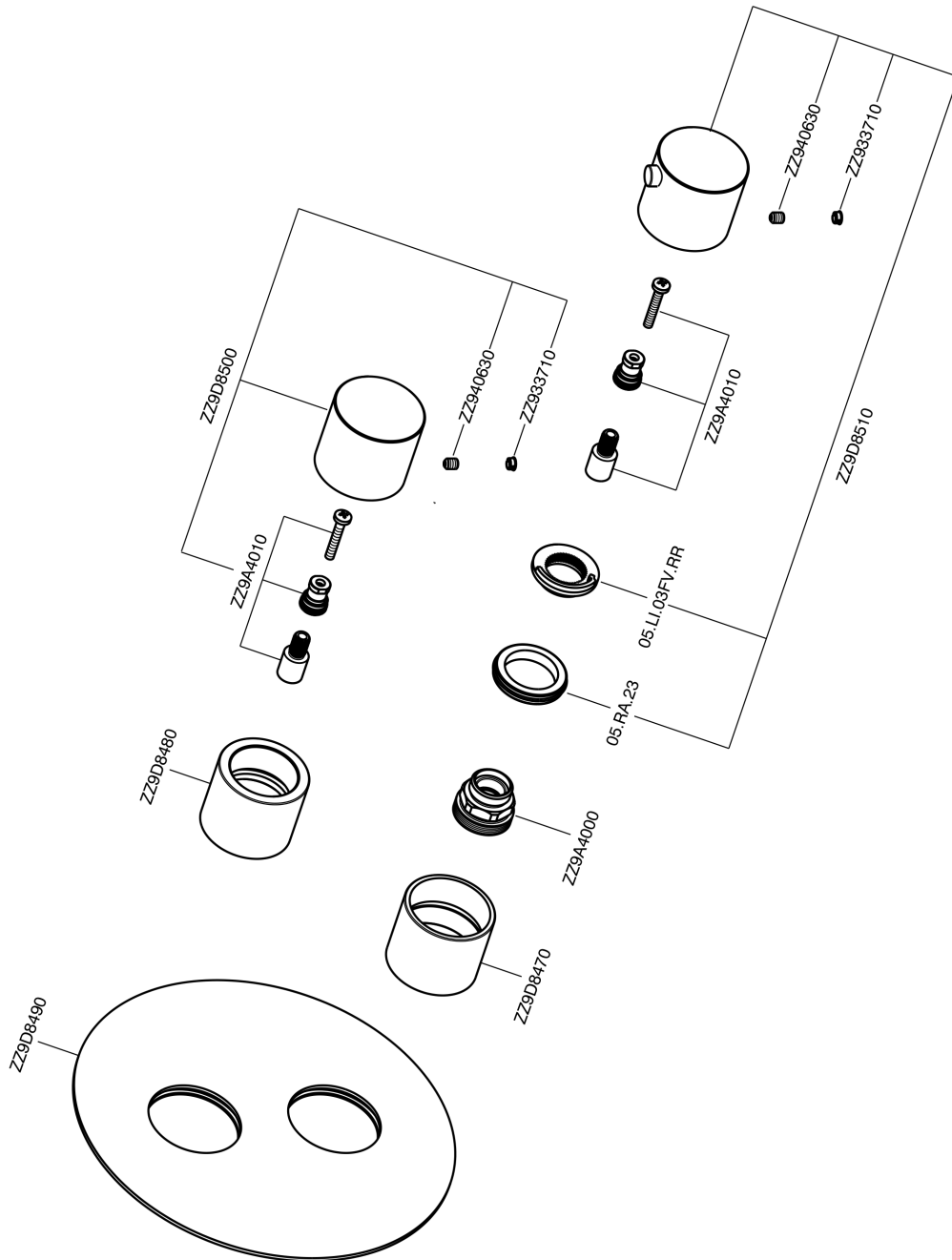

X3007300

<https://en.cisal.it/exposed-part-for-con-thermo-shower-valve-1-outlet-smooth-x32-x3007300>

## Concealed thermostatic shower valve, 1-outlet CONCEALED\_ZA007301

MODEL **ZA007301**

Concealed thermostatic shower valve,  
1-outlet, Stopvalve with 1/2" outlet, without trim kit



AVAILABLE FINISHINGS



CHARACTERISTICS

Concealed **1**  
Cartridge Spare Parts **24.04A.PP**  
**8x20 Plus P Thermostatic Valve**

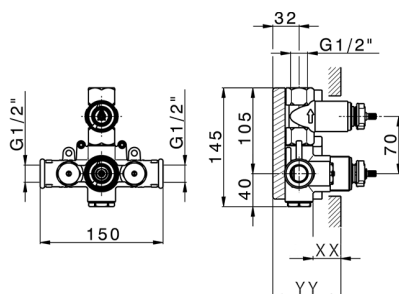

Piastra/Plate/Plaque/Platte/Placa  
2-3mm: XX 25-40 YY 76-91  
10mm: XX 16-31 YY 65-80



### Thermostatic

The Cisal thermostatic is your personal water manager, helping you to handle, control and save water and energy.



2026-07-03