

Cover Part for 2 Function Concealed Thermo Valve NUOVA LESS_LN01R200

MODEL **LN01R200**

Cover Part for 2 Function Concealed Thermo Valve, for item ZA01R200

AVAILABLE FINISHINGS

-  **21** 21 Chrome
-  **2F** 2F Brushed Nickel
-  **40** 40 Matt Black
-  **4Q** 4Q Matt White

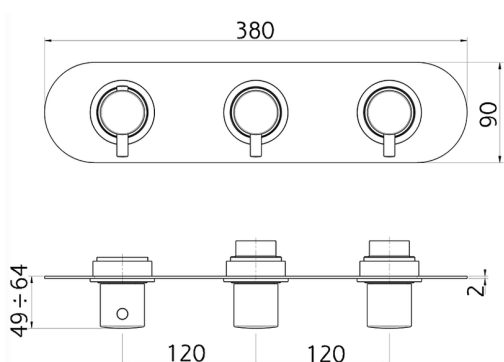
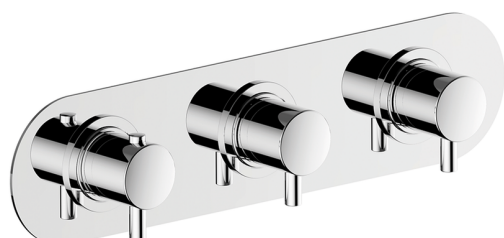

CHARACTERISTICS

Installation **Concealed**
 Required concealed parts **ZA01R200**



Thermostatic

The Cisal thermostatic is your personal water manager, helping you to handle, control and save water and energy.



2 Function Concealed Thermostatic Valve CONCEALED_ZA01R200

MODEL **ZA01R200**

2 Function Concealed Thermostatic Valve

AVAILABLE FINISHINGS



04 04 Without finishing



CHARACTERISTICS

Concealed **1**
 Cartridge Spare Parts **23.51A.HF**
HF Thermostatic Valve

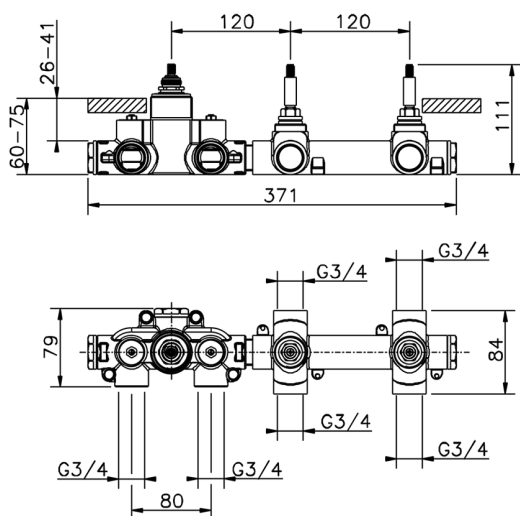

Thermostatic

The Cisal thermostatic is your personal water manager, helping you to handle, control and save water and energy.



2024-12-29