

## Glass holder ARCANA COMPONENTS\_AR090500

MODEL **AR090500**

Glass holder, wall mounted glass holder



### AVAILABLE FINISHINGS

-  **21** 21 Chrome
-  **24** 24 Gold
-  **26** 26 Old Copper
-  **27** 27 Old Bronze
-  **2A** 2A Satin Brushed Nickel
-  **74** 74 Chrome/Gold

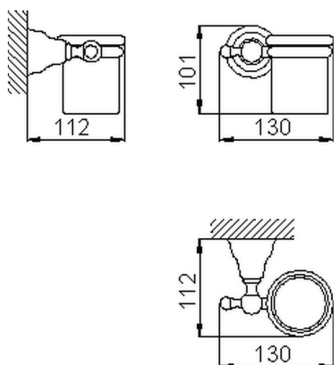

### CHARACTERISTICS



2026-06-06