

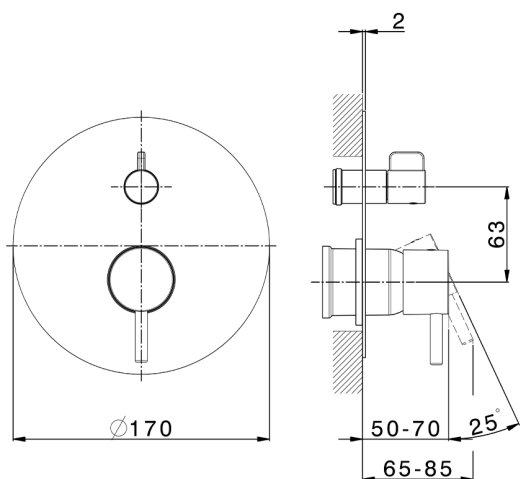









Exposed part for concealed S.L.bath-shower valve NUOVA LESS_LN002300C

MODEL **LN002300C**

Exposed part for concealed S.L.bath-shower valve, 2-Way rotating diverter, without concealed part, for items Easy-Box ZA000230



AVAILABLE FINISHINGS

-  **21** 21 Chrome
-  **2F** 2F Brushed Nickel
-  **40** 40 Matt Black
-  **4Q** 4Q Matt White
-  **2W** 2W Brushed Gold
-  **26** 26 Old Copper
-  **3W** 3W Brushed Black Titanium
-  **43** 43 Salvia
-  **44** 44 Graphite
-  **45** 45 Argilla
-  **46** 46 Metal Bronze
-  **47** 47 Cemento

CHARACTERISTICS

Installation	Concealed
Required concealed parts	ZA000230

