

Single lever tall washbasin mixer ALMA_A3003540



MODEL **A3003540**

Single lever tall washbasin mixer, without automatic pop-up waste, G.3/8" stainless steel flexible hoses

AVAILABLE FINISHINGS

-  **21** 21 Chrome
-  **2F** 2F Brushed Nickel
-  **40** 40 Matt Black

CHARACTERISTICS

Cartridge Spare Parts **ZZ95435000**

35 mm Cartridge

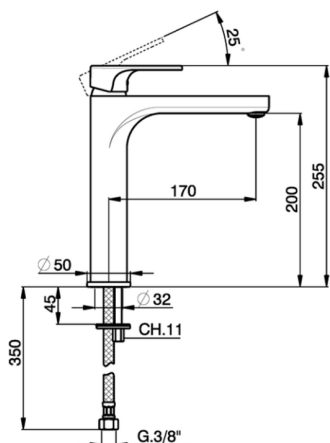

EcoStop

EcoStop feature limits water flow to approximately 50% of maximum output with one point of resistance on setting. Push slightly past the middle stop only when full water output is required. This will save water up to 50%.



Single lever tall washbasin mixer ALMA_A3003540

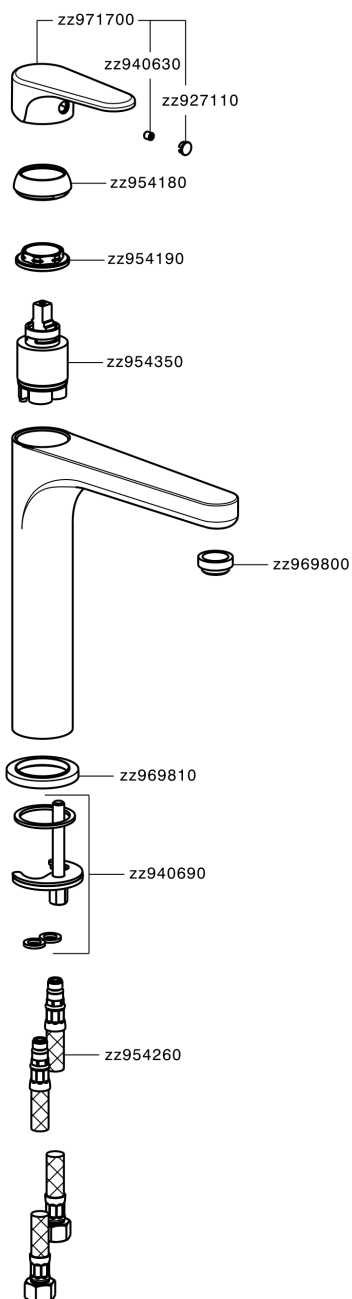

A3003540

<https://en.cisal.it/single-lever-tall-washbasin-mixer-alma-a3003540>

2026-04-30