

Exposed part for con.thermo.shower valve 1-outlet ROADSTER ACCENT_RA007300

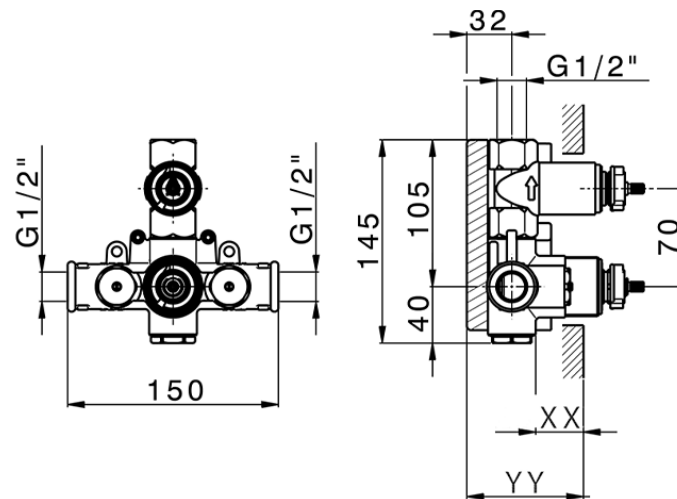

RA007300

<https://en.cisal.it/exposed-part-for-con-thermo-shower-valve-1-outlet-roadster-accent-ra007300>



Piastra/Plate/Plaque/Platte/Placa
 2-3mm: XX 25-40 YY 76-91
 10mm: XX 16-31 YY 65-80

ZA007301

<https://en.cisal.it/concealed-thermostatic-shower-valve-1-outlet-concealed-za007301>

2026-05-19