

Single lever washbasin mixer NUOVA LESS_LN000510



MODEL **LN000510**

Single lever washbasin mixer, with 1"1/4 automatic pop-up waste, G.3/8" stainless steel flexible hoses

AVAILABLE FINISHINGS

-  **21** 21 Chrome
-  **2F** 2F Brushed Nickel
-  **40** 40 Matt Black
-  **4Q** 4Q Matt White

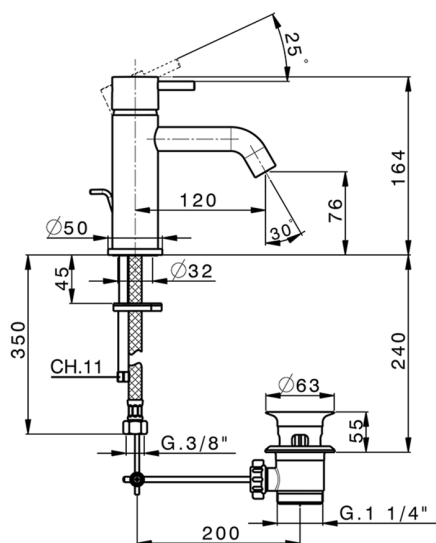

CHARACTERISTICS

Cartridge Spare Parts **ZZ99672000**

35 mm Cartridge



EcoStop

EcoStop feature limits water flow to approximately 50% of maximum output with one point of resistance on setting. Push slightly past the middle stop only when full water output is required. This will save water up to 50%.



Single lever washbasin mixer NUOVA LESS_LN000510

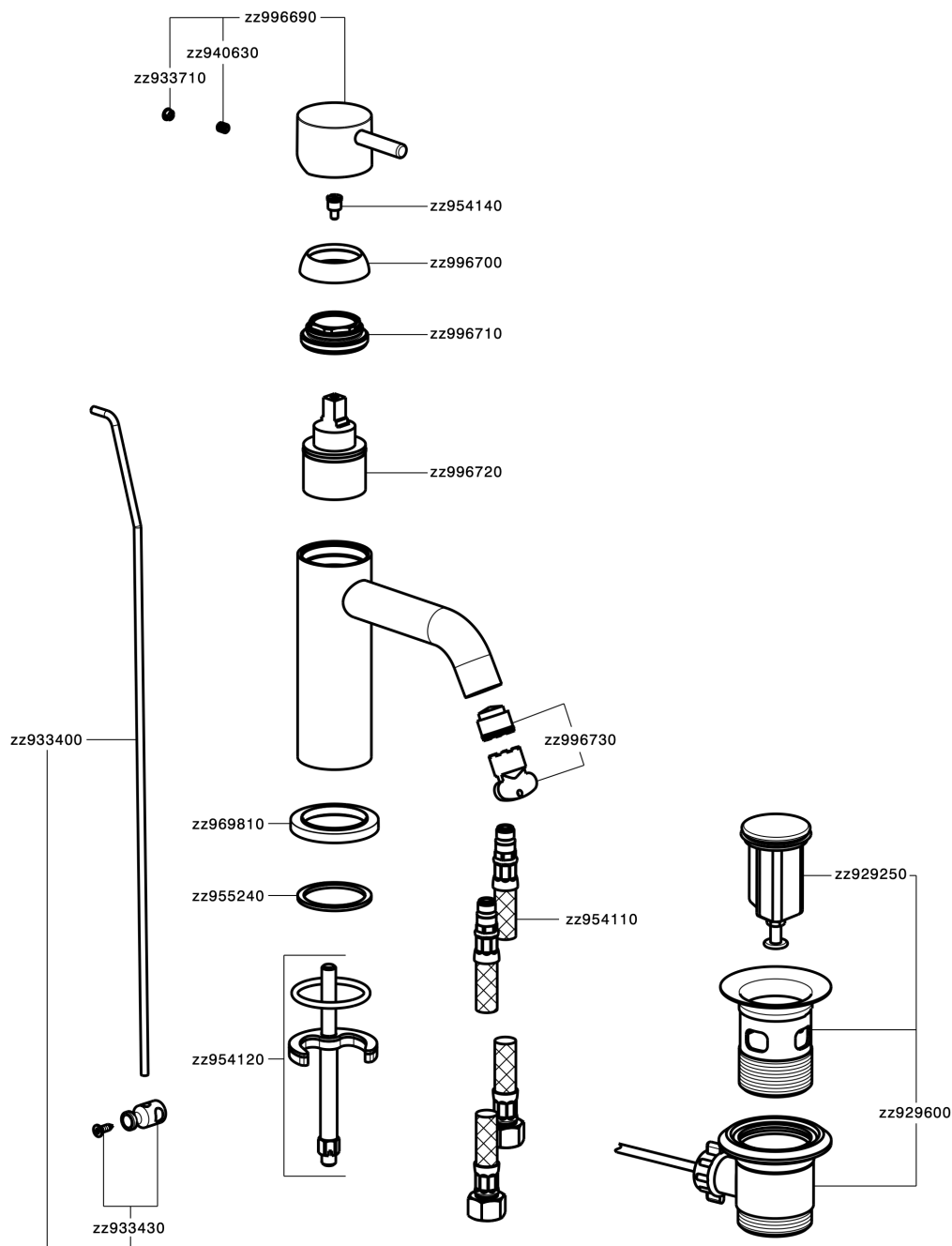

LN000510

<https://en.cisal.it/single-lever-washbasin-mixer-nuova-less-ln000510>

2026-04-26