

## Exposed part for con.thermo.shower mixer, 2-outlet **CHERIE\_CF019100**



MODEL **CF019100**

Exposed part for con.thermo.shower mixer, 2-outlet, with 2 outlet deviator, without concealed part, for item ZA019100

### AVAILABLE FINISHINGS

- 
**6T** 6T Chrome/Matt Black
- 
**7C** 7C Gold/Matt Black
- 
**7D** 7D Polished Nickel/Matt Black
- 
**7E** 7E Rose Gold/Matt Black



### CHARACTERISTICS

Installation **Concealed**  
 Required concealed parts **ZA019100**



### Thermostatic

The Cisal thermostatic is your personal water manager, helping you to handle, control and save water and energy.



## Concealed thermostatic shower mixer, 2-outlets CONCEALED\_ZA019100

MODEL **ZA019100**

Concealed thermostatic shower mixer, 2-outlets, with 1/2" 2 outlet devia stop cartridge, without trim kit



AVAILABLE FINISHINGS



**04** 04 Without finishing

CHARACTERISTICS

Concealed **1**  
 Cartridge Spare Parts **24.04A.PP**

**8x20 Plus P Thermostatic Valve**

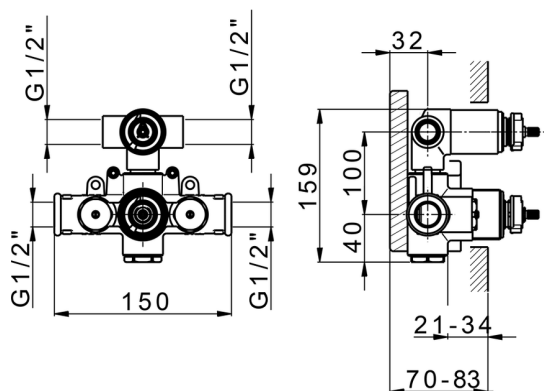

### DeviaStop

The Cisal Devia Stop technology allows to adjust the water flow and to direct it to the selected output point (overhead soaker, hand shower, etc).



### Thermostatic

The Cisal thermostatic is your personal water manager, helping you to handle, control and save water and energy.



2026-04-29