

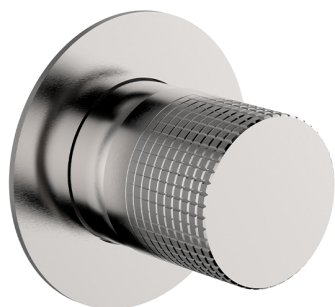



Exposed part for concealed S.L. shower valve NUANCE X32_X1003000

MODEL **X1003000**

Exposed part for concealed S.L. shower valve, without concealed part, for item ZA005300-ZA005301, Inox AISI 316L



AVAILABLE FINISHINGS

-  **D1** D1 Brushed Inox
-  **5H** 5H Dark Brass Brushed
-  **5L** 5L Brushed Black Titanium
-  **5N** 5N Brushed Rose Gold

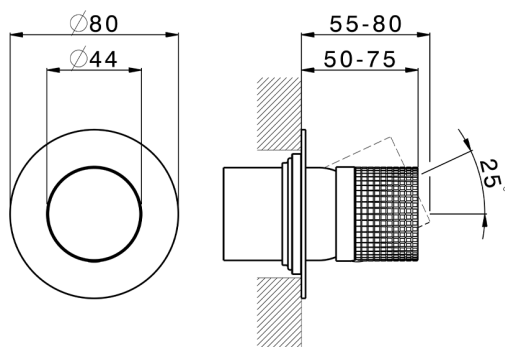

CHARACTERISTICS

Installation **Concealed**
 Required concealed parts **ZA005301**
ZA005300



Exposed part for concealed S.L. shower valve NUANCE X32_X1003000

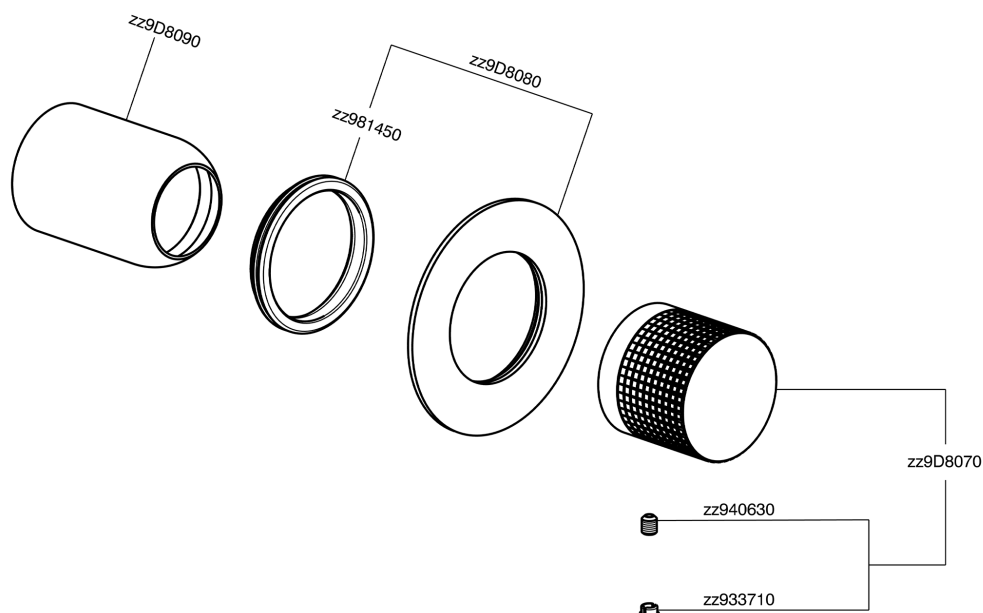

X1003000

<https://en.cisal.it/exposed-part-for-concealed-s-l-shower-valve-nuance-x32-x1003000>

Concealed single lever shower mixer CONCEALED_ZA005301

MODEL **ZA005301**

Concealed single lever shower mixer, 1/2" concealed shower, without trim kit, with noise reducers



AVAILABLE FINISHINGS



CHARACTERISTICS

Concealed **1**
 Cartridge Spare Parts **ZZ94035000**
35 mm Cartridge

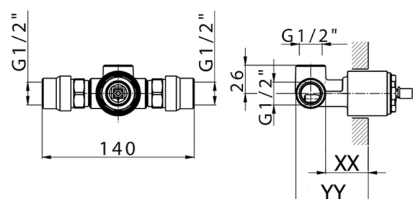

Piastra/Plate/Plaque/Platte/Placa
 2-3mm: XX 27-47 YY 54-74
 10mm: XX 16-40 YY 43-68



Concealed single lever shower mixer CONCEALED_ZA005300



MODEL **ZA005300**

Concealed single lever shower mixer, 1/2" concealed shower, without trim kit

AVAILABLE FINISHINGS



04 04 Without finishing

CHARACTERISTICS

Concealed **1**
 Cartridge Spare Parts **ZZ94035000**
35 mm Cartridge



Piastra/Plate/Plaque/Platte/Placa
 2-3mm: XX 27-47 YY 54-74
 10mm: XX 16-40 YY 43-68



2026-05-17