

Exposed part for Thermostatic One Box Valve LESS MINIMAL_LM0BT030

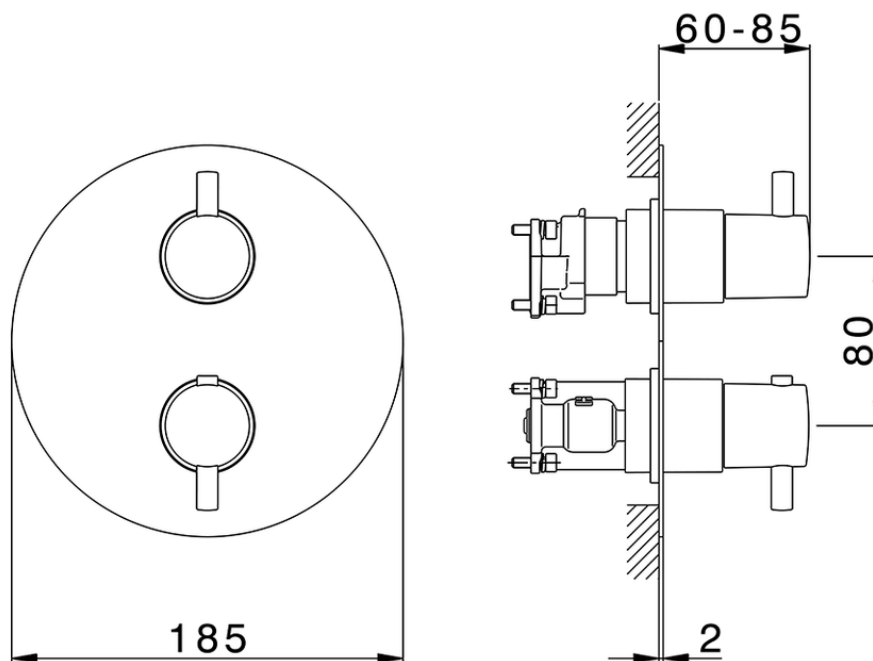

LM0BT030

<https://en.cisal.it/exposed-part-for-thermostatic-one-box-valve-less-minimal-lm0bt030>



ZA00B031

<https://en.cisal.it/one-box-universal-concealed-part-one-box-za00b031>



ZA00B030

<https://en.cisal.it/one-box-universal-concealed-part-one-box-za00b030>

2026-05-19