

Stopvalve exposed part CHERIE_CX003310

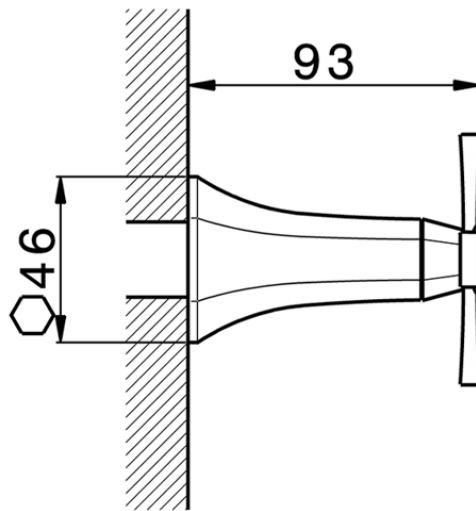

CX003310

<https://en.cisal.it/stopvalve-exposed-part-cherie-cx003310>

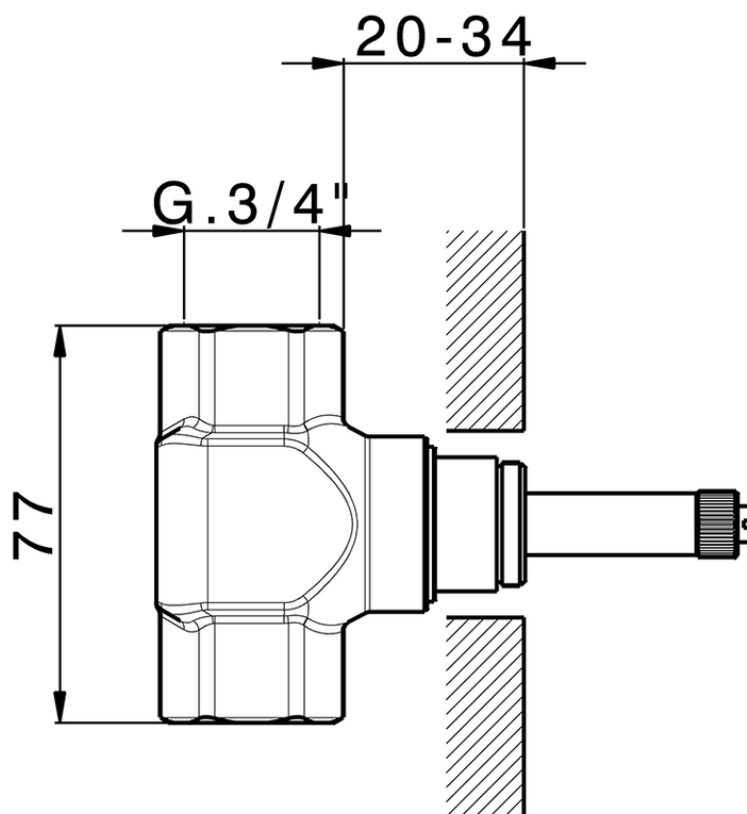

ZA003311

<https://en.cisal.it/3-4-stopvalve-concealed-part-concealed-za003311>

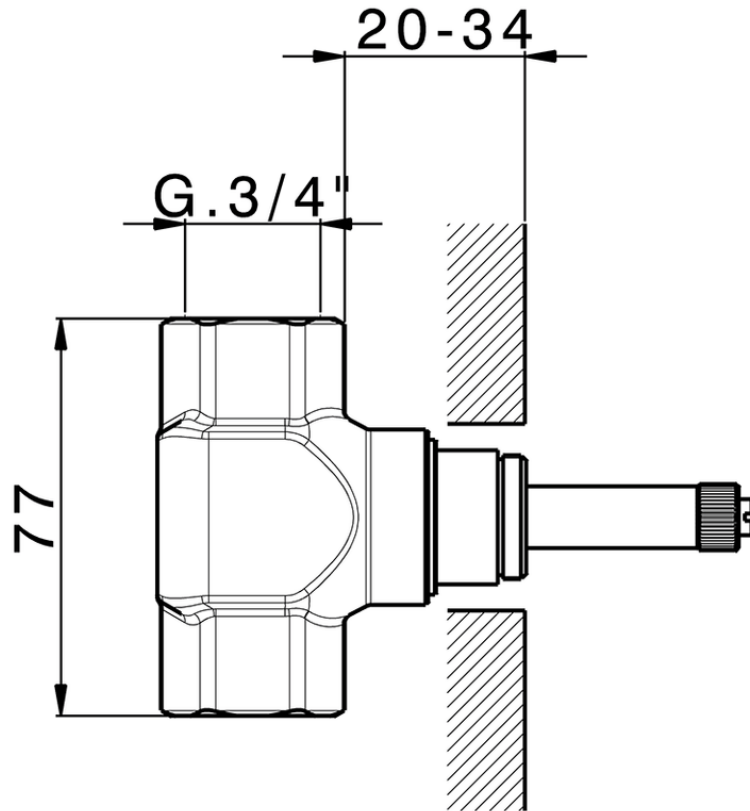

ZA003310

<https://en.cisal.it/3-4-stopvalve-concealed-part-concealed-za003310>

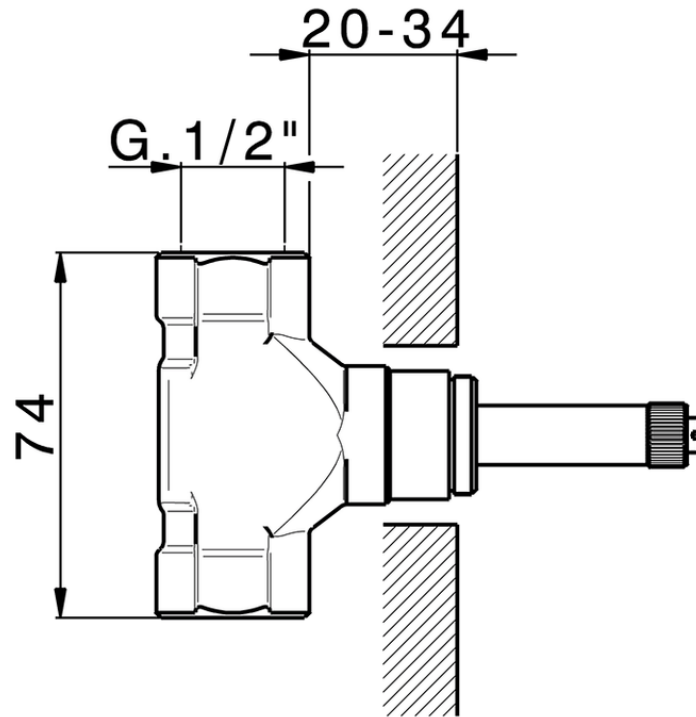

ZA003321

<https://en.cisal.it/1-2-stopvalve-concealed-part-concealed-za003321>

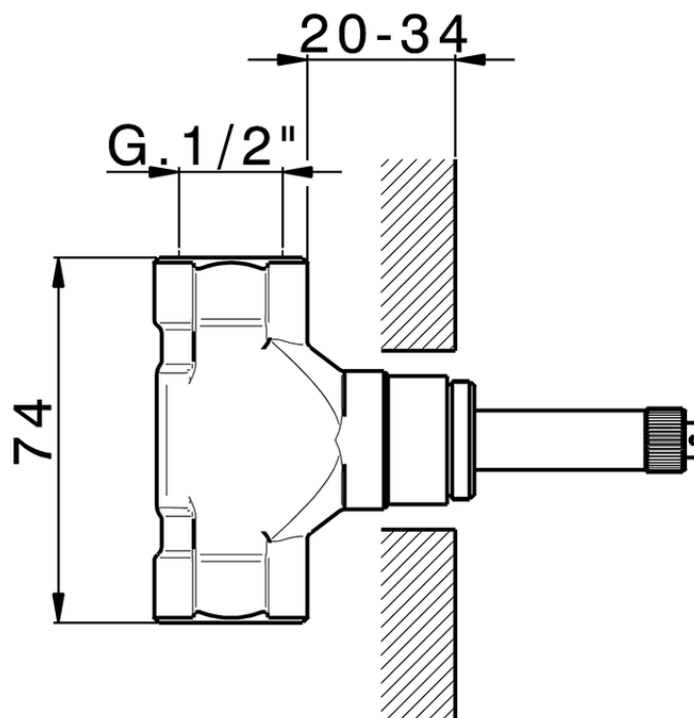

ZA003320

<https://en.cisal.it/1-2-stopvalve-concealed-part-concealed-za003320>

2026-04-10