

Cover Part for 3 Function Concealed Thermo Valve WELLNESS_GS00R300

MODEL **GS00R300**

Cover Part for 3 Function Concealed Thermo Valve, for item ZA00R300 horizontal installation, for item ZA00V300 vertical installation



AVAILABLE FINISHINGS

-  **21** 21 Chrome
-  **2F** 2F Brushed Nickel
-  **2W** 2W Brushed Gold
-  **5H** 5H Dark Brass Brushed
-  **5L** 5L Brushed Black Titanium
-  **6T** 6T Chrome/Matt Black

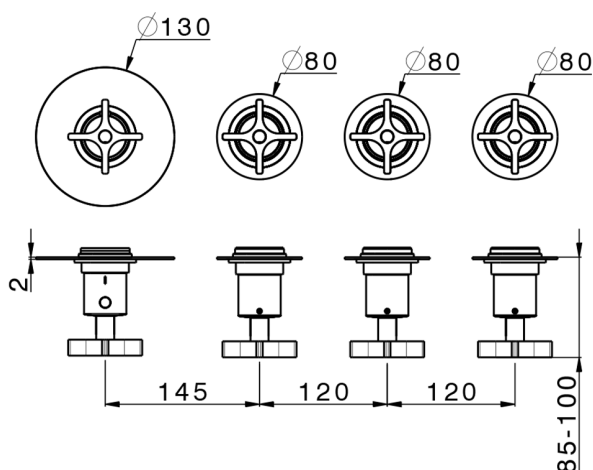

CHARACTERISTICS

Installation **Concealed**
 Required concealed parts **ZA00V300**
ZA00R300



Thermostatic

The Cisal thermostatic is your personal water manager, helping you to handle, control and save water and energy.



3 Function Concealed Thermostatic Built-in Part CONCEALED_ZA00V300

MODEL **ZA00V300**

3 Function Concealed Thermostatic Built-in Part

AVAILABLE FINISHINGS

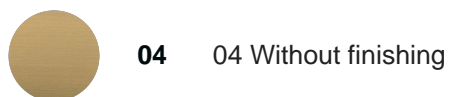

CHARACTERISTICS

Concealed **1**
 Cartridge Spare Parts **23.51A.HF**
HF Thermostatic Valve

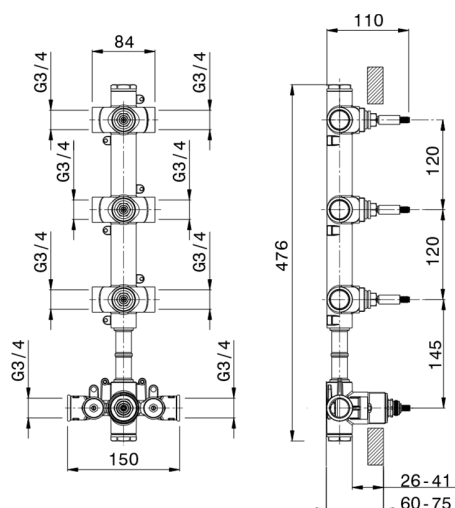

Thermostatic

The Cisal thermostatic is your personal water manager, helping you to handle, control and save water and energy.



3 Function Concealed Thermostatic Built-in Part CONCEALED_ZA00R300

MODEL **ZA00R300**

3 Function Concealed Thermostatic Built-in Part

AVAILABLE FINISHINGS

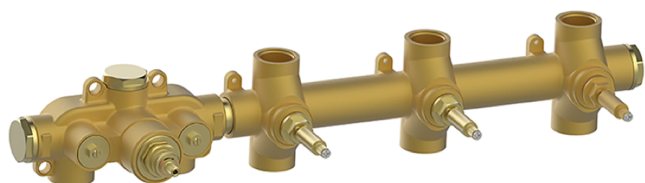
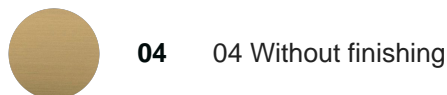

CHARACTERISTICS

Concealed **1**
 Cartridge Spare Parts **23.51A.HF**
HF Thermostatic Valve

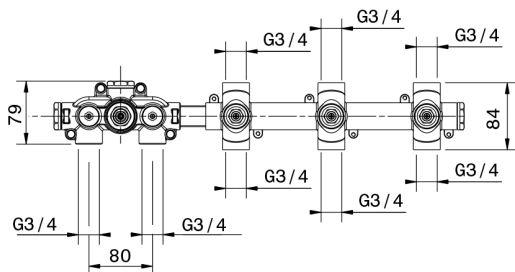
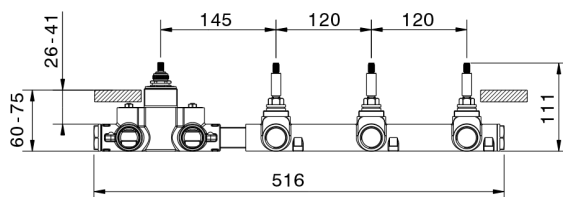

Thermostatic

The Cisal thermostatic is your personal water manager, helping you to handle, control and save water and energy.



2024-11-01