

Exposed part for concealed washbasin mixer SMOOTH X32_X4013511

MODEL **X4013511**

Exposed part for concealed washbasin mixer, without concealed part, for item ZA033510, with smooth handles, Inox AISI 316L

AVAILABLE FINISHINGS

-  **D1** D1 Brushed Inox
-  **5H** 5H Dark Brass Brushed
-  **5L** 5L Brushed Black Titanium
-  **5N** 5N Brushed Rose Gold

CHARACTERISTICS

Installation **Concealed**

Required concealed parts **ZA033510**

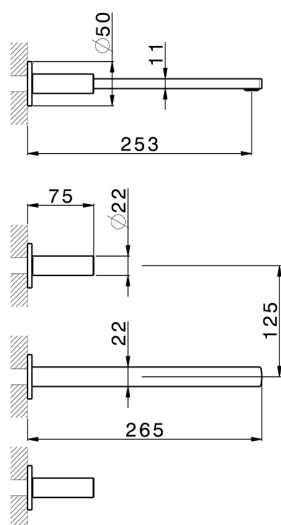

Exposed part for concealed washbasin mixer SMOOTH X32_X4013511

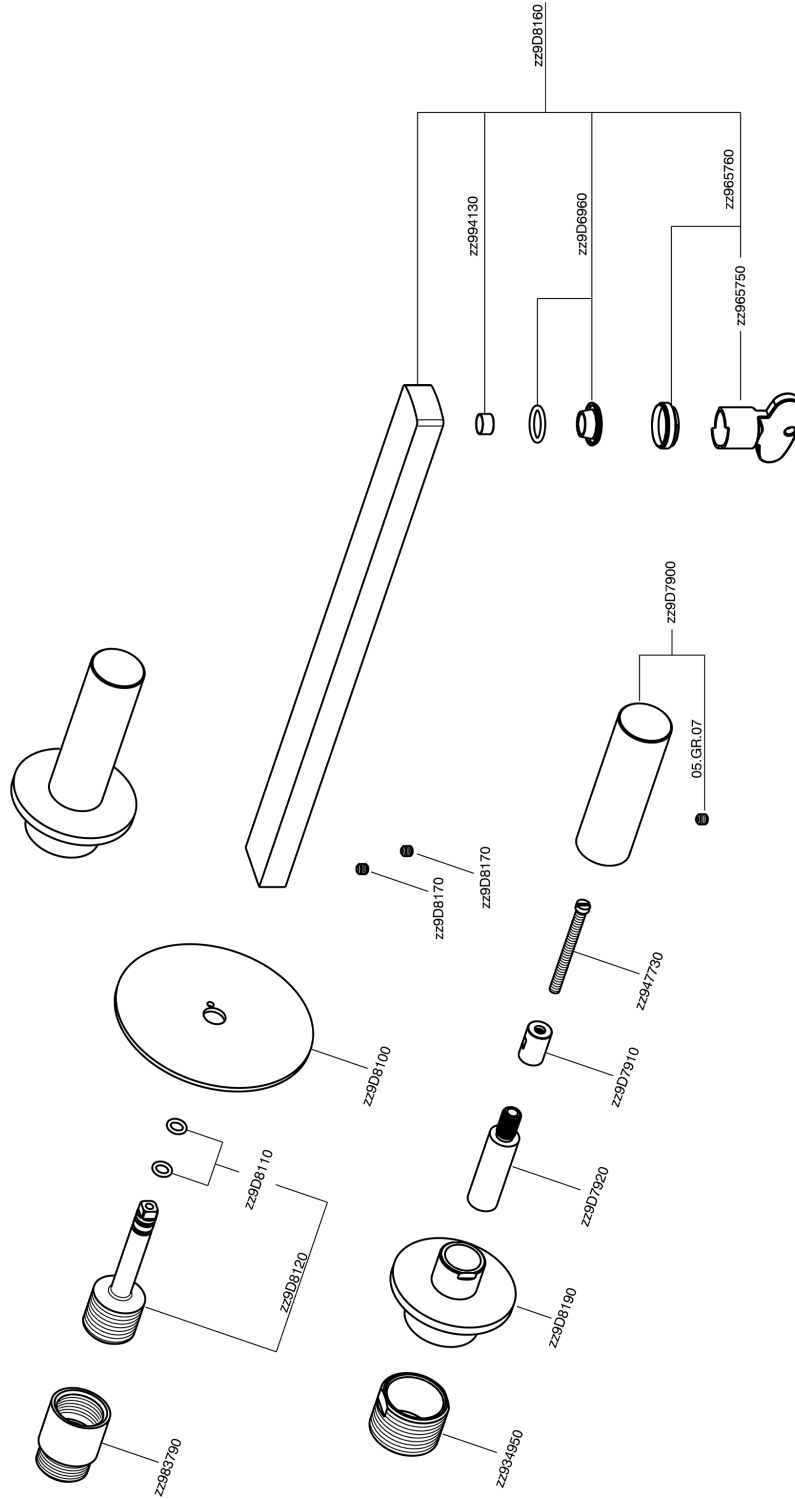

X4013511

<https://en.cisal.it/exposed-part-for-concealed-washbasin-mixer-smooth-x32-x4013511>

Concealed washbasin mixer CONCEALED_ZA033510

MODEL **ZA033510**

Concealed washbasin mixer, with two right headvalves

AVAILABLE FINISHINGS

 **04** 04 Without finishing



CHARACTERISTICS

Concealed **1**



2026-06-05