



Cover Part for 2 Function Concealed Thermo. Valve WAVE_WE01R200

MODEL **WE01R200**

Cover Part for 2 Function Concealed Thermo.Valve,for item ZA01R200

AVAILABLE FINISHINGS

-  **21** 21 Chrome
-  **2F** 2F Brushed Nickel
-  **2Q** 2Q Black Titanium

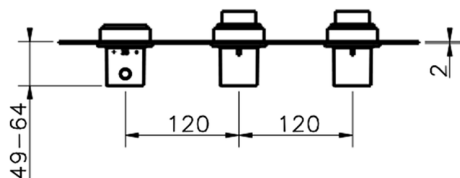
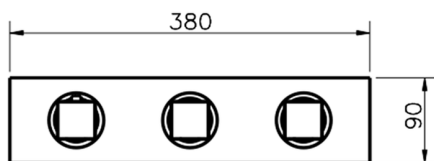
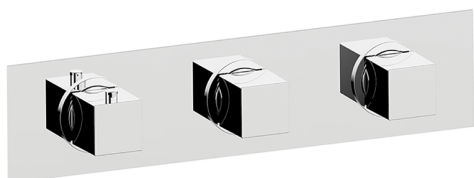

CHARACTERISTICS

Installation **Concealed**

Required concealed parts **ZA01R200**



Thermostatic

The Cisal thermostatic is your personal water manager, helping you to handle, control and save water and energy.



2 Function Concealed Thermostatic Valve CONCEALED_ZA01R200

MODEL **ZA01R200**

2 Function Concealed Thermostatic Valve

AVAILABLE FINISHINGS

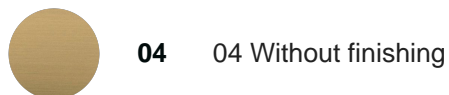

CHARACTERISTICS

Concealed **1**
 Cartridge Spare Parts **23.51A.HF**
HF Thermostatic Valve

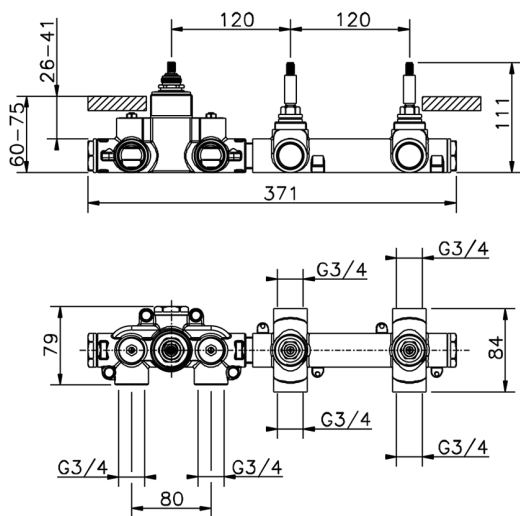

Thermostatic

The Cisal thermostatic is your personal water manager, helping you to handle, control and save water and energy.



2025-12-16