

Exposed part for Single Lever One Box Valve ONE BOX_RI0BM010



MODEL **RI0BM010**

Exposed part for Single Lever One Box Valve, 1 Outlet, Minimum depth of installation: 67 mm, without concealed part, for items ZA00B030-ZA00B031

AVAILABLE FINISHINGS

-  **21** 21 Chrome
-  **6V** 6V Matt White/Brushed Nickel
-  **5G** 5G Rose Gold
-  **4Q** 4Q Matt White
-  **40** 40 Matt Black
-  **2W** 2W Brushed Gold
-  **2F** 2F Brushed Nickel
-  **24** 24 Gold
-  **6X** 6X Matt White/Brushed Gold
-  **7W** 7W Matt Black/Brushed Gold

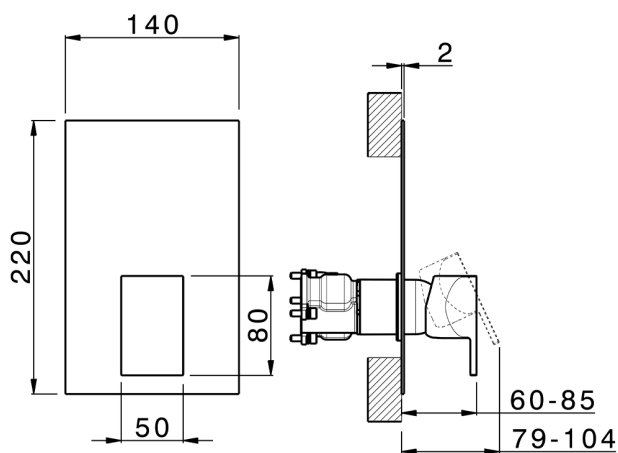

CHARACTERISTICS

Cartridge Spare Parts **ZZ97179000**

35 mm Cartridge

Installation **Concealed**

Required concealed parts **ZA00B031**

ZA00B030



One Box Universal Concealed Part ONE BOX_ZA00B031

MODEL **ZA00B031**

One Box Universal Concealed Part, for 1, 2 or 3 outlet thermostatic or single lever, without trim kit, with noise reducers, with sealing gasket

AVAILABLE FINISHINGS

 **04** 04 Without finishing

CHARACTERISTICS

Concealed **1**

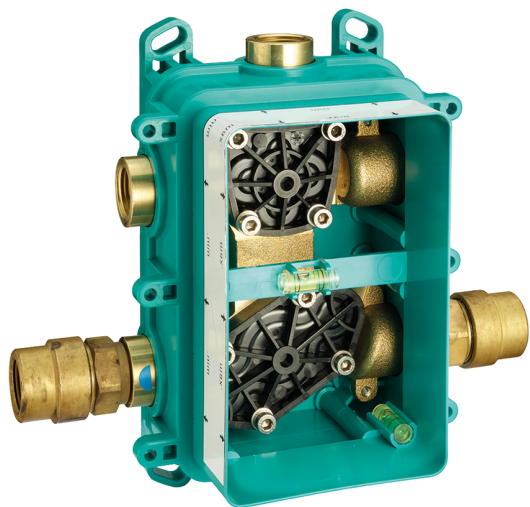

Thermostatic

The Cisal thermostatic is your personal water manager, helping you to handle, control and save water and energy.



One Box Universal Concealed Part ONE BOX_ZA00B030

MODEL **ZA00B030**

One Box Universal Concealed Part, for 1, 2 or 3 outlet thermostatic or single lever, without trim kit, without noise reducers, with sealing gasket

AVAILABLE FINISHINGS

 **04** 04 Without finishing

CHARACTERISTICS

Concealed **1**



Thermostatic

The Cisal thermostatic is your personal water manager, helping you to handle, control and save water and energy.



2024-12-31