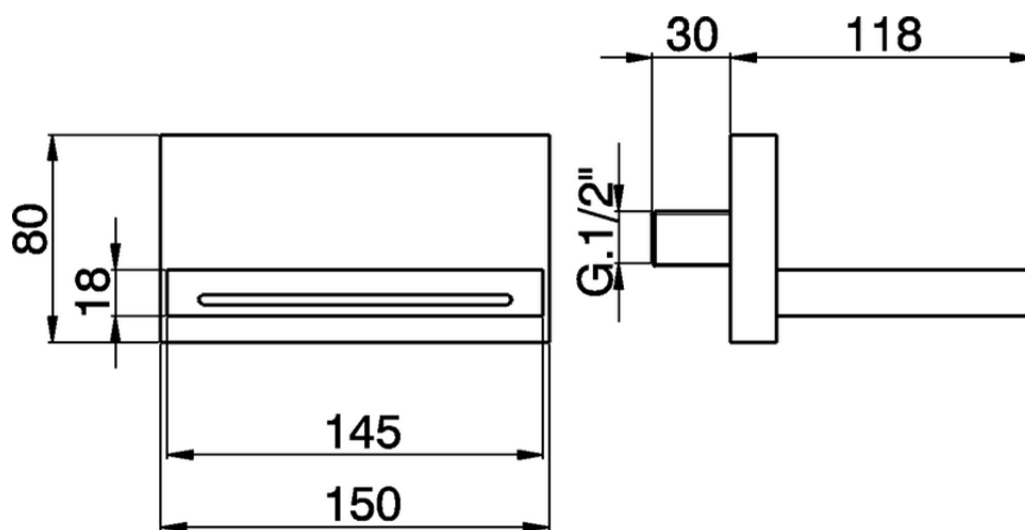

Spout COMPONENTS_ZA002200

ZA002200

<https://en.cisal.it/spout-components-za002200>

2026-06-13