

S.L. basin mixer- tall version - EnergySave CUBIC_CU003545

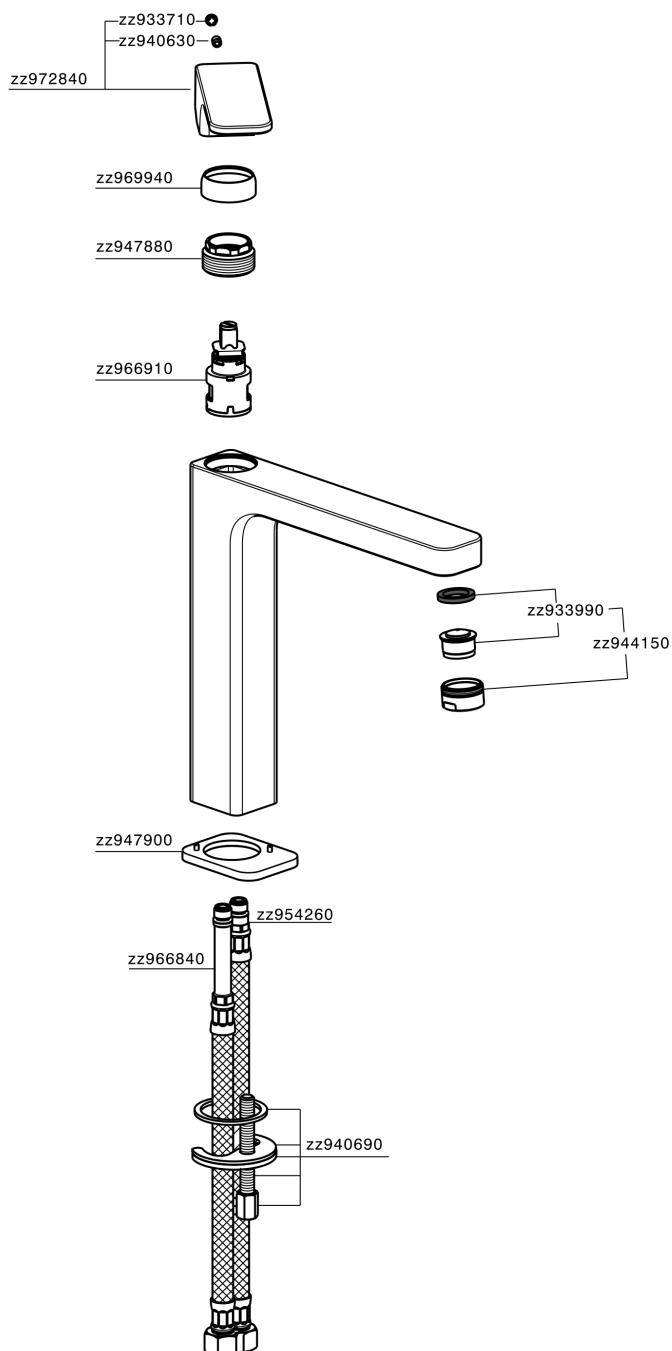

CU003545

<https://en.cisal.it/s-l-basin-mixer-tall-version-energysave-cubic-cu003545>

2026-04-10