





## Cover Part for 3 Function Concealed Thermo. Valve WELLNESS\_X100R300



MODEL **X100R300**

Cover Part for 3 Function Concealed Thermo.Valve,for item ZA00R300 horizontal installation,for item ZA00V300 vertical installation,Inox AISI 316L

### AVAILABLE FINISHINGS

-  **D1** D1 Brushed Inox
-  **5H** 5H Dark Brass Brushed
-  **5L** 5L Brushed Black Titanium
-  **5N** 5N Brushed Rose Gold

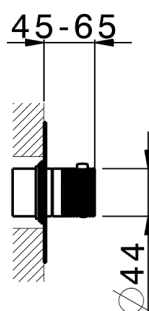
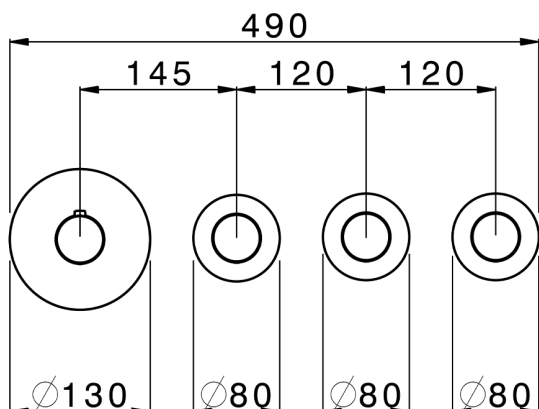

### CHARACTERISTICS

Installation **Concealed**  
 Required concealed parts **ZA00V300**  
**ZA00R300**



### Thermostatic

The Cisal thermostatic is your personal water manager, helping you to handle, control and save water and energy.



## Cover Part for 3 Function Concealed Thermo. Valve WELLNESS\_X100R300

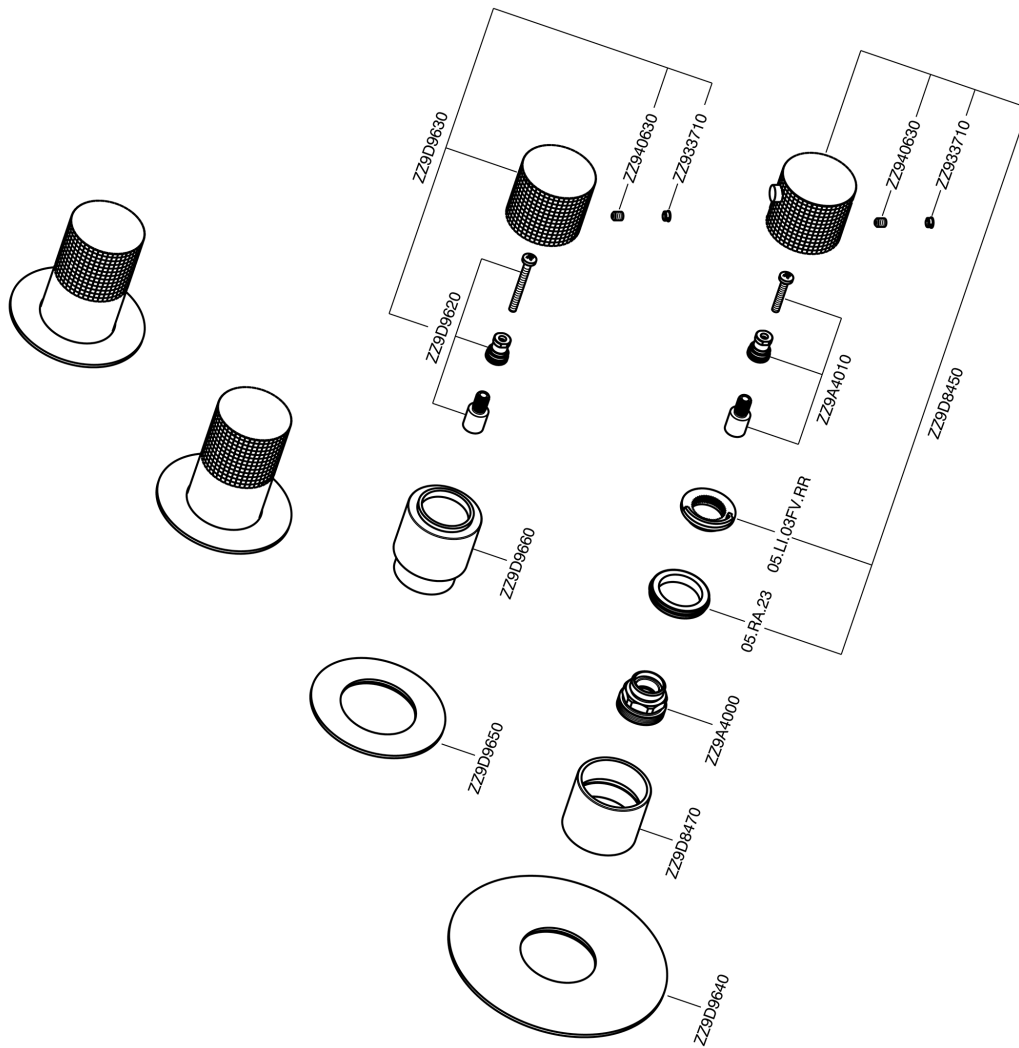

X100R300

<https://en.cisal.it/cover-part-for-3-function-concealed-thermo-valve-wellness-x100r300>

## 3 Function Concealed Thermostatic Built-in Part CONCEALED\_ZA00V300

MODEL **ZA00V300**

3 Function Concealed Thermostatic Built-in Part

AVAILABLE FINISHINGS



CHARACTERISTICS

Concealed **1**  
 Cartridge Spare Parts **23.51A.HF**  
**HF Thermostatic Valve**

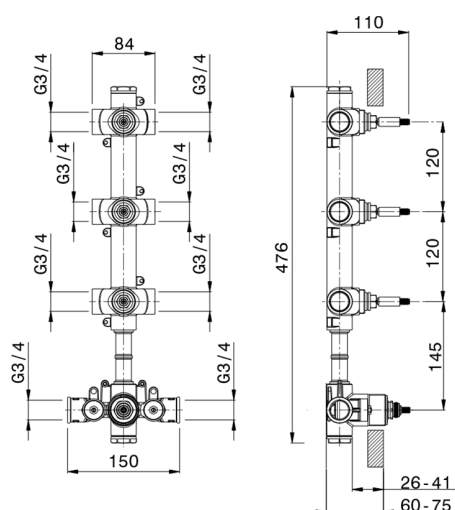

### Thermostatic

The Cisal thermostatic is your personal water manager, helping you to handle, control and save water and energy.



## 3 Function Concealed Thermostatic Built-in Part CONCEALED\_ZA00R300

MODEL **ZA00R300**

3 Function Concealed Thermostatic Built-in Part

AVAILABLE FINISHINGS

 **04** 04 Without finishing

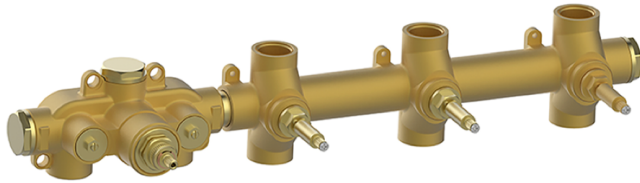

CHARACTERISTICS

Concealed **1**  
 Cartridge Spare Parts **23.51A.HF**

**HF Thermostatic Valve**

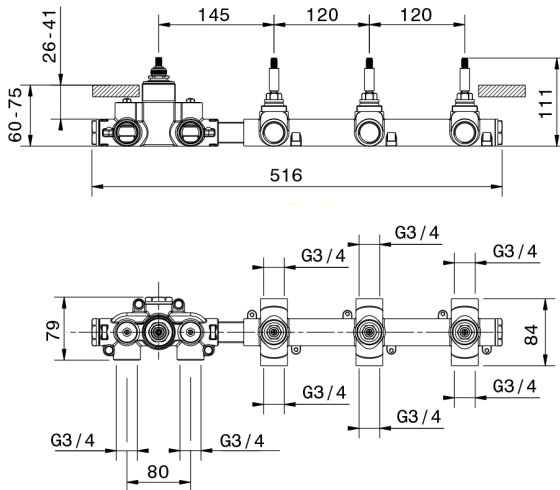

### Thermostatic

The Cisal thermostatic is your personal water manager, helping you to handle, control and save water and energy.



2026-06-13