

## Exposed part for con.thermo.shower mixer, 2-outlet **CHERIE\_CE019100**

MODEL **CE019100**

Exposed part for con.thermo.shower mixer, 2-outlet, with 2 outlet deviator, without concealed part, for item ZA019100

### AVAILABLE FINISHINGS

-  **21** 21 Chrome
-  **24** 24 Gold
-  **2B** 2B Polished Nickel
-  **2P** 2P Rose Gold

### CHARACTERISTICS

Installation **Concealed**  
 Required concealed parts **ZA019100**

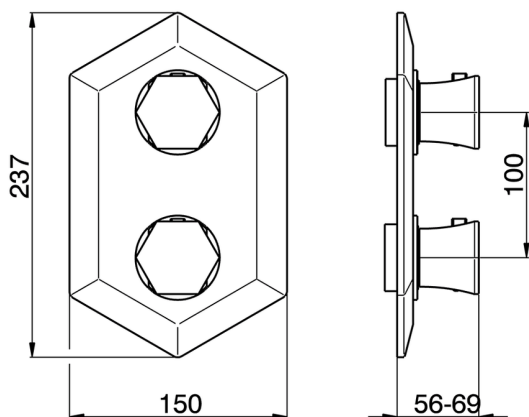

### Thermostatic

The Cisal thermostatic is your personal water manager, helping you to handle, control and save water and energy.



## Exposed part for con.thermo.shower mixer, 2-outlet CHERIE\_CE019100

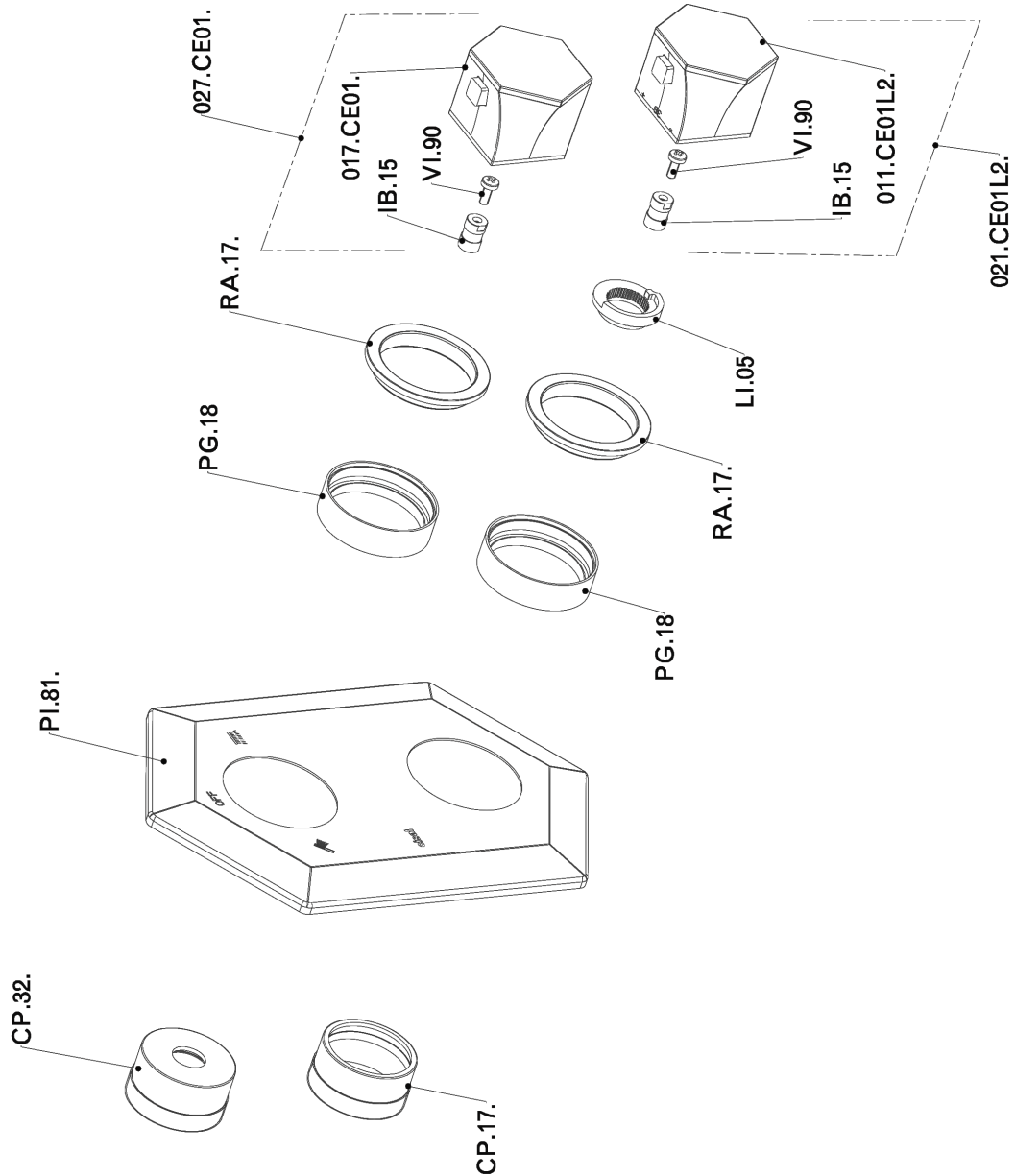

CE019100

<https://en.cisal.it/exposed-part-for-con-thermo-shower-mixer-2-outlet-cherie-ce019100>

## Concealed thermostatic shower mixer, 2-outlets CONCEALED\_ZA019100

MODEL **ZA019100**

Concealed thermostatic shower mixer, 2-outlets, with 1/2" 2 outlet devia stop cartridge, without trim kit



AVAILABLE FINISHINGS

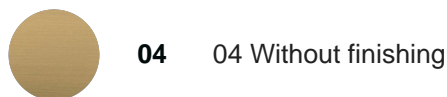

CHARACTERISTICS

Concealed **1**  
 Cartridge Spare Parts **24.04A.PP**  
**8x20 Plus P Thermostatic Valve**

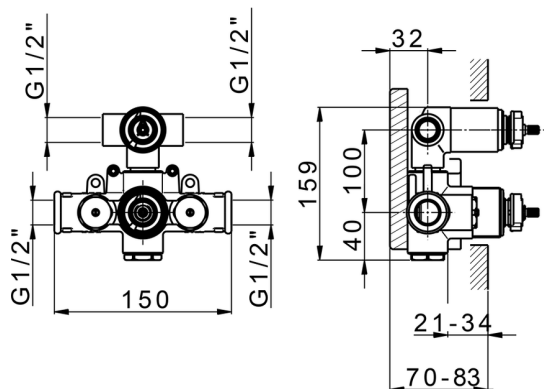

### DeviaStop

The Cisal Devia Stop technology allows to adjust the water flow and to direct it to the selected output point (overhead soaker, hand shower, etc).



### Thermostatic

The Cisal thermostatic is your personal water manager, helping you to handle, control and save water and energy.



2026-04-09