

Exposed part for concealed thermo shower valve ROADSTER ACCENT_RA007200

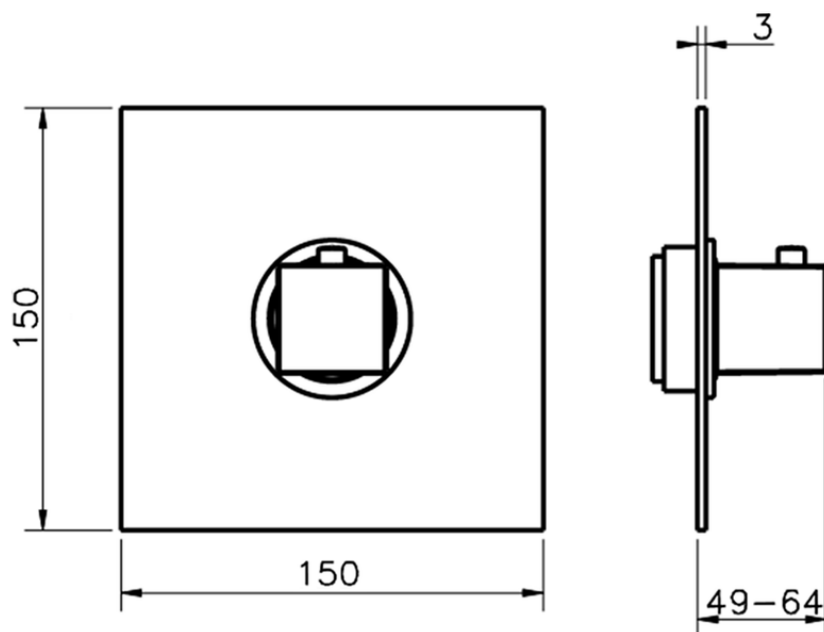

RA007200

<https://en.cisal.it/exposed-part-for-concealed-thermo-shower-valve-roadster-accent-ra007200>



Piastra/Plate/Plaque/Platte/Placa

2-3mm: XX 25-40 YY 76-91

10mm: XX 16-31 YY 65-80

ZA007220

<https://en.cisal.it/3-4-concealed-thermostatic-valve-concealed-za007220>

2026-06-14