



Exposed part for concealed S.L. shower valve ALMA_A3003000

MODEL **A3003000**

Exposed part for concealed S.L. shower valve, without concealed part, for item ZA005300



AVAILABLE FINISHINGS

-  **21** 21 Chrome
-  **2F** 2F Brushed Nickel
-  **40** 40 Matt Black

CHARACTERISTICS

Installation **Concealed**

Required concealed parts **ZA005300**

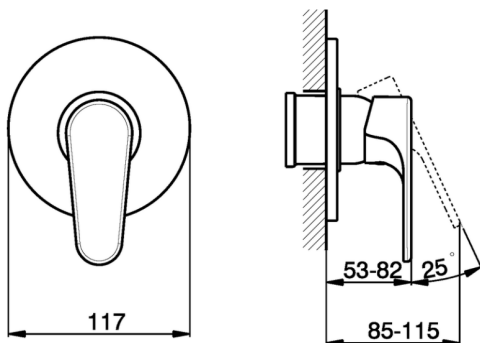

Exposed part for concealed S.L. shower valve ALMA_A3003000

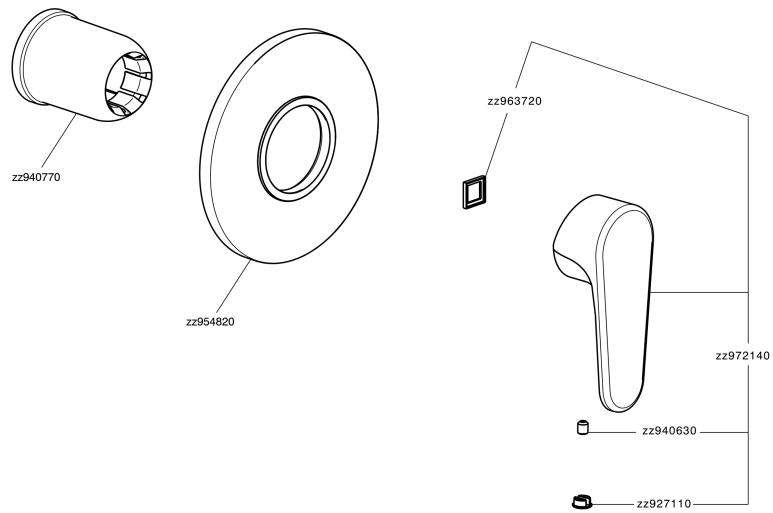

A3003000

<https://en.cisal.it/exposed-part-for-concealed-s-l-shower-valve-agma-a3003000>

Concealed single lever shower mixer CONCEALED_ZA005300



MODEL **ZA005300**

Concealed single lever shower mixer, 1/2" concealed shower, without trim kit

AVAILABLE FINISHINGS



04 04 Without finishing

CHARACTERISTICS

Concealed **1**
 Cartridge Spare Parts **ZZ94035000**
35 mm Cartridge



Piastra/Plate/Plaque/Platte/Placa
 2-3mm: XX 27-47 YY 54-74
 10mm: XX 16-40 YY 43-68



2026-05-19