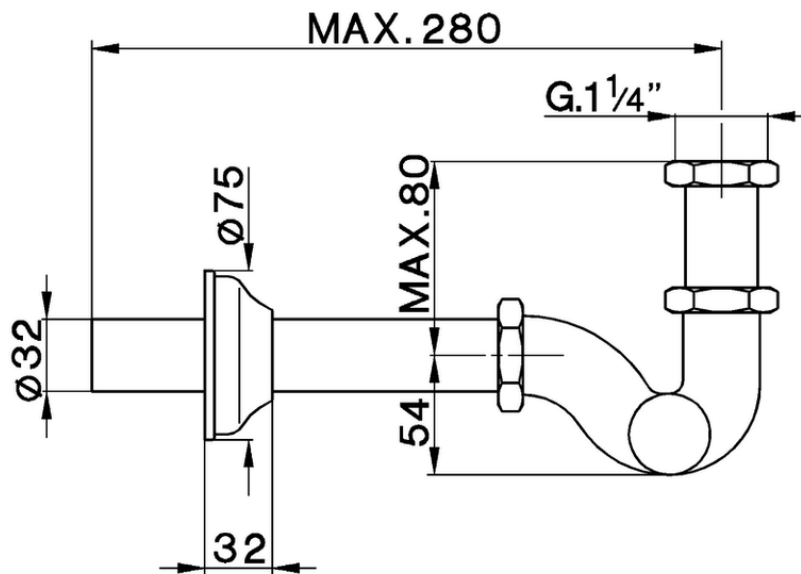

1 1/4 S-shaped siphon COMPONENTS_ZA004110

ZA004110

<https://en.cisal.it/11-4-s-shaped-siphon-components-za004110>

2026-05-20