

3 Function Concealed Thermostatic Built-in Part CONCEALED_ZA01R300

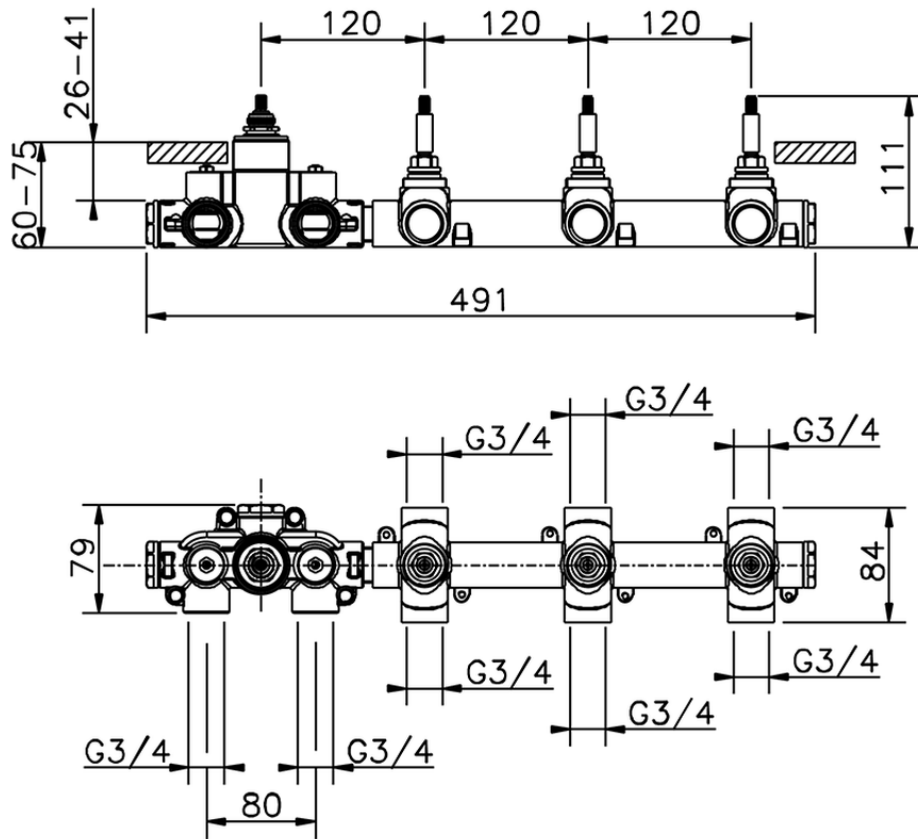

ZA01R300

<https://en.cisal.it/3-function-concealed-thermostatic-built-in-part-concealed-za01r300>

2026-05-19