

Exposed part for con.thermo.shower mixer 1-outlet HI-RISE_RI009300

RI009300

<https://en.cisal.it/exposed-part-for-con-thermo-shower-mixer-1-outlet-hi-rise-ri009300>

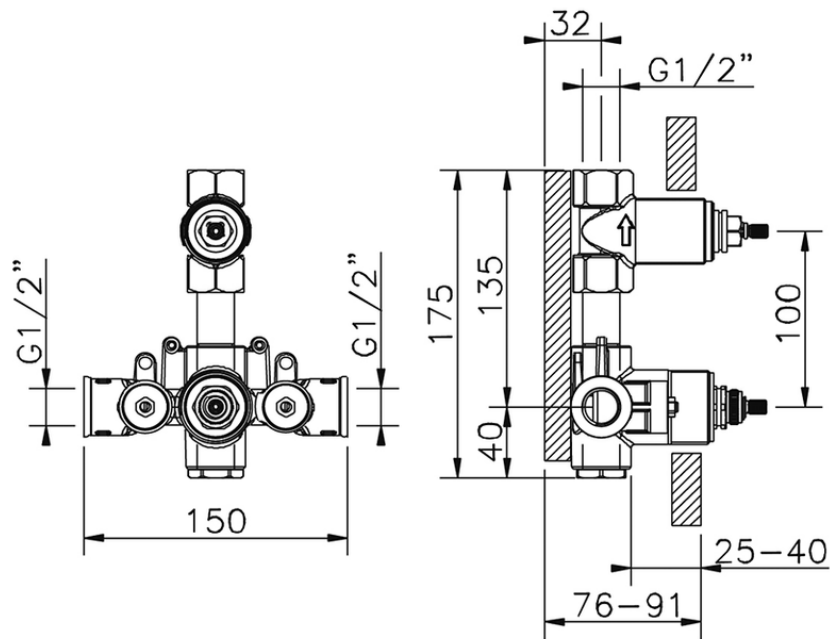

ZA009301

<https://en.cisal.it/concealed-thermostatic-shower-mixer-1-outlet-concealed-za009301>

2026-05-19