

## Exposed part for Thermostatic One Box Valve HI-RISE\_RI0BT030

MODEL **RI0BT030**

Exposed part for Thermostatic One Box Valve, with 1-2-3 outlet deviator, Minimum depth of installation: 67 mm, without concealed part, for items ZA00B030-ZA00B031

### AVAILABLE FINISHINGS

- 
**21** 21 Chrome
- 
**24** 24 Gold
- 
**2F** 2F Brushed Nickel
- 
**2W** 2W Brushed Gold
- 
**40** 40 Matt Black
- 
**6X** 6X Matt White/Brushed Gold
- 
**6V** 6V Matt White/Brushed Nickel
- 
**5G** 5G Rose Gold
- 
**4Q** 4Q Matt White
- 
**7W** 7W Matt Black/Brushed Gold

### CHARACTERISTICS

Cartridge Spare Parts **24.04A.PP**

**8x20 Plus P Thermostatic Valve**

Installation **Concealed**

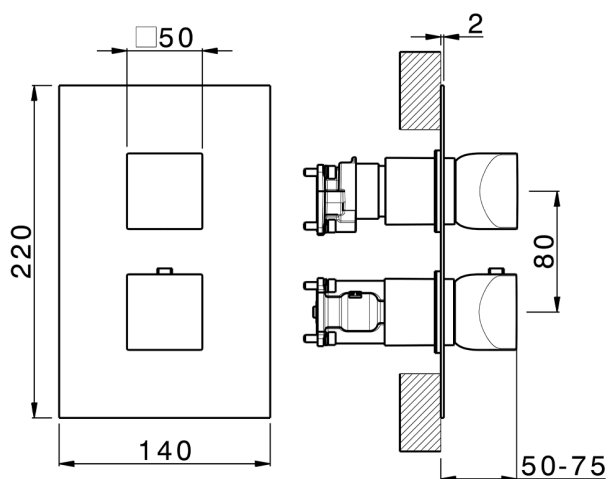
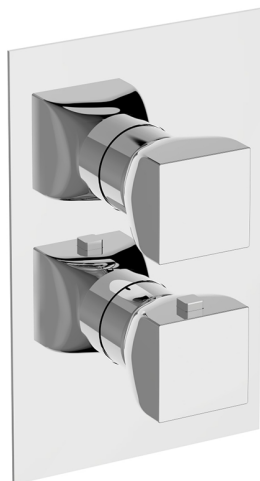

Required concealed parts **ZA00B031**

**ZA00B030**



### **DeviaStop**

The Cisal Devia Stop technology allows to adjust the water flow and to direct it to the selected output point (overhead soaker, hand shower, etc).



### **Thermostatic**

The Cisal thermostatic is your personal water manager, helping you to handle, control and save water and energy.



## One Box Universal Concealed Part ONE BOX\_ZA00B031

MODEL **ZA00B031**

One Box Universal Concealed Part, for 1, 2 or 3 outlet thermostatic or single lever, without trim kit, with noise reducers, with sealing gasket

AVAILABLE FINISHINGS

 **04** 04 Without finishing

CHARACTERISTICS

Concealed **1**



### Thermostatic

The Cisal thermostatic is your personal water manager, helping you to handle, control and save water and energy.



## One Box Universal Concealed Part ONE BOX\_ZA00B030

MODEL **ZA00B030**

One Box Universal Concealed Part, for 1, 2 or 3 outlet thermostatic or single lever, without trim kit, without noise reducers, with sealing gasket

AVAILABLE FINISHINGS

 **04** 04 Without finishing

CHARACTERISTICS

Concealed **1**



### Thermostatic

The Cisal thermostatic is your personal water manager, helping you to handle, control and save water and energy.



2024-11-23