





Exposed part for concealed S.L.bath-shower valve **CHERIE_CH002100**

MODEL **CH002100**

Exposed part for concealed S.L.bath-shower valve, 2 outlet automatic diverter, without concealed part, for item ZA004210 - ZA004213



AVAILABLE FINISHINGS

- 
6T 6T Chrome/Matt Black
- 
7C 7C Gold/Matt Black
- 
7D 7D Polished Nickel/Matt Black
- 
7E 7E Rose Gold/Matt Black

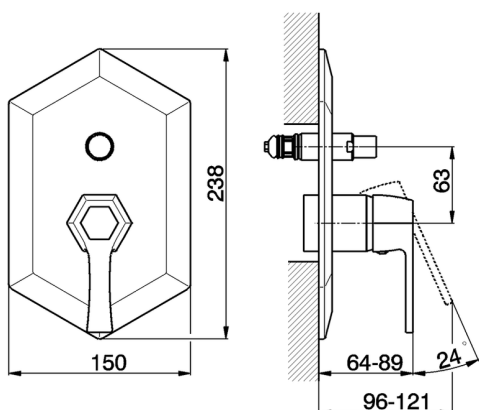

CHARACTERISTICS

Installation **Concealed**
 Required concealed parts **ZA004213**
ZA004210



Exposed part for concealed S.L.bath-shower valve CHERIE_CH002100

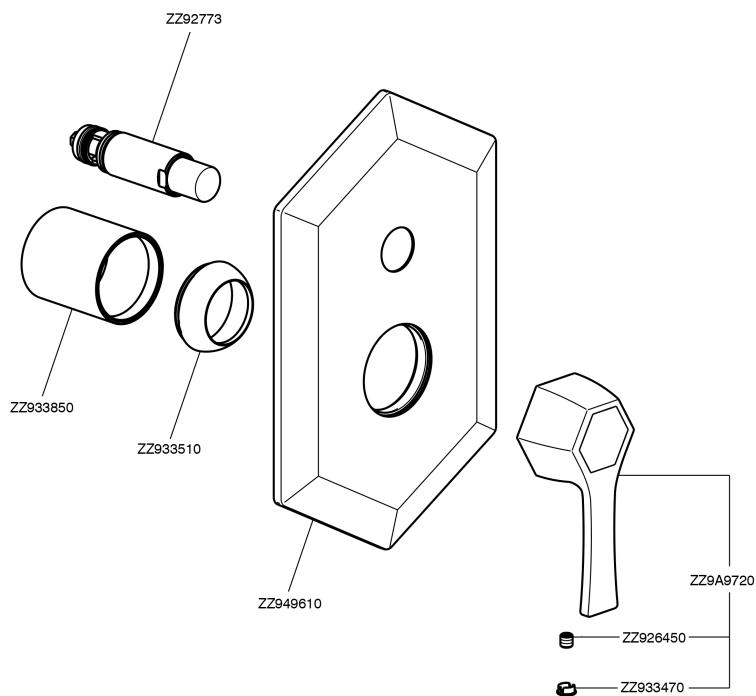

CH002100

<https://en.cisal.it/exposed-part-for-concealed-s-l-bath-shower-valve-cherie-ch002100>

Concealed single lever bath-shower mixer CONCEALED_ZA004210

MODEL **ZA004210**

Concealed single lever bath-shower mixer, automatic diverter, with noise reducers, without trim kit

AVAILABLE FINISHINGS



04 04 Without finishing

CHARACTERISTICS

Concealed **1**
 Cartridge Spare Parts **ZZ93196000**
38 mm Cartridge

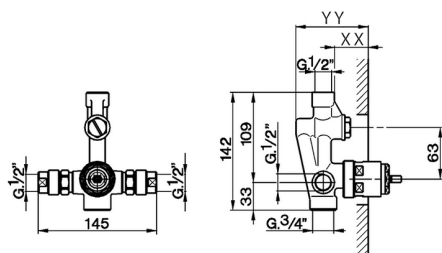

Piastra/Plate/Plaque/Platte/Placa
 2-3mm: XX 25-55 YY 72-102
 10mm: XX 15-40 YY 62-87



2026-06-14