

Shower arm ARCANA COMPONENTS_AR001540

MODEL **AR001540**

Shower arm, L.200 mm



AVAILABLE FINISHINGS

-  **21** 21 Chrome
-  **24** 24 Gold
-  **26** 26 Old Copper
-  **27** 27 Old Bronze
-  **2A** 2A Satin Brushed Nickel
-  **74** 74 Chrome/Gold

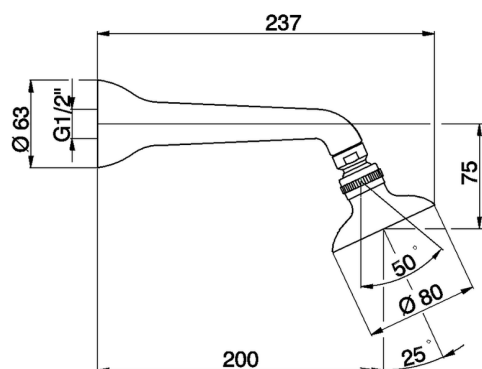

CHARACTERISTICS



2026-06-13