

Thermostatic shower mixer LINEAVIVA_LVT01010

MODEL **LVT01010**

Thermostatic shower mixer, without shower set, 1/2" M flexible connection

AVAILABLE FINISHINGS

-  **21** 21 Chrome
-  **2B** 2B Polished Nickel
-  **2F** 2F Brushed Nickel
-  **40** 40 Matt Black
-  **4Q** 4Q Matt White

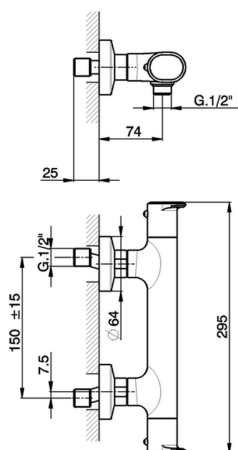

CHARACTERISTICS

Cartridge Spare Parts **ZZ96551000**

TMX 25 Thermostatic Valve



EcoStop

EcoStop feature limits water flow to approximately 50% of maximum output with one point of resistance on setting. Push slightly past the middle stop only when full water output is required. This will save water up to 50%.



SafeTouch

The Cisal SafeTouch system maintains the mixer body cool to the touch during operation.



Thermostatic

The Cisal thermostatic is your personal water manager, helping you to handle, control and save water and energy.



Thermostatic shower mixer LINEAVIVA_LVT01010

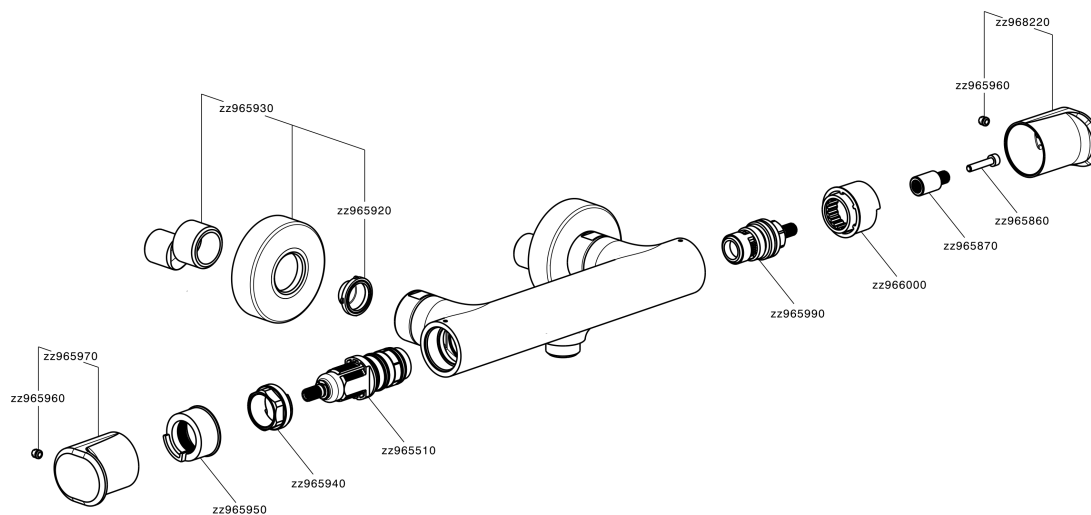

LVT01010

<https://en.cisal.it/thermostatic-shower-mixer-lineaviva-lvt01010>

2026-06-13