

Spout COMPONENTS_ZA001252

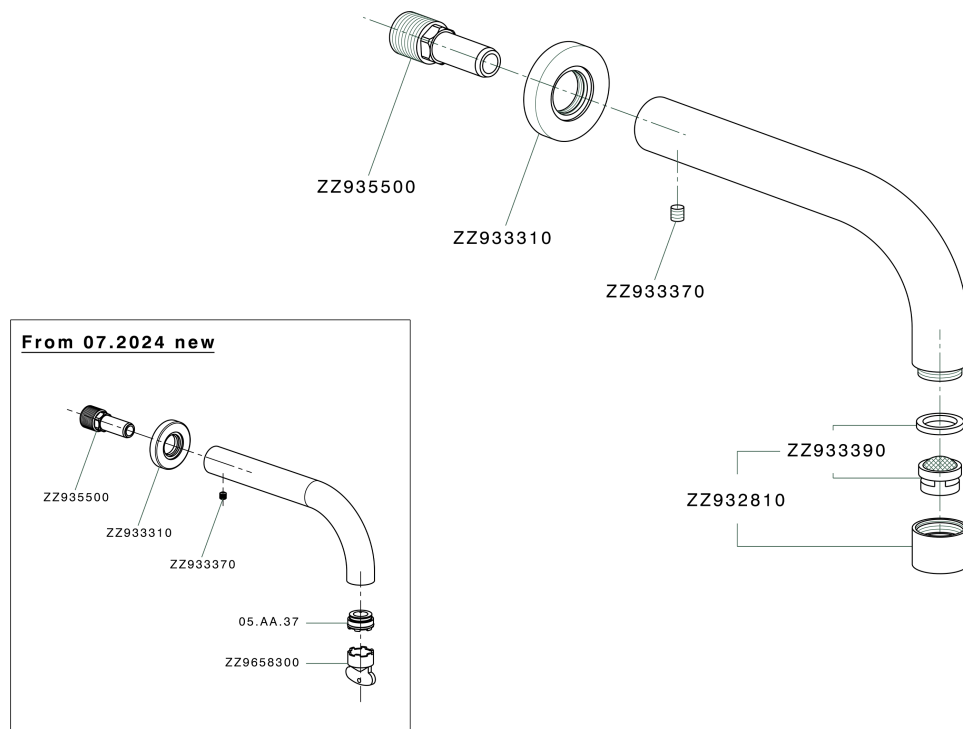

ZA001252

<https://en.cisal.it/spout-components-za001252>

2026-05-20