

Washbasin electronic mixer TRONIC_ER000540

MODEL **ER000540**

Washbasin electronic mixer, without automatic pop-up waste, G.1/2" F Stainless Steel Flexible Hose, net and battery supply, AA batteries not included



AVAILABLE FINISHINGS



CHARACTERISTICS

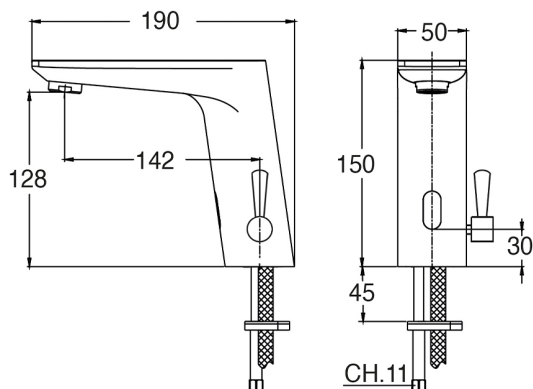

2026-05-19