

Single lever 'large' washbasin mixer ALMA_A3000500



MODEL **A3000500**

Single lever 'large' washbasin mixer, without automatic pop-up waste, G.3/8" stainless steel flexible hoses

AVAILABLE FINISHINGS

-  **21** 21 Chrome
-  **2F** 2F Brushed Nickel
-  **40** 40 Matt Black

CHARACTERISTICS

Cartridge Spare Parts **ZZ95435000**

35 mm Cartridge

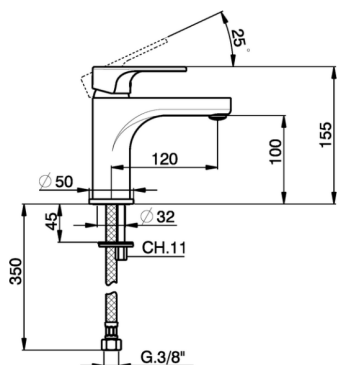

EcoStop

EcoStop feature limits water flow to approximately 50% of maximum output with one point of resistance on setting. Push slightly past the middle stop only when full water output is required. This will save water up to 50%.



Single lever 'large' washbasin mixer ALMA_A3000500

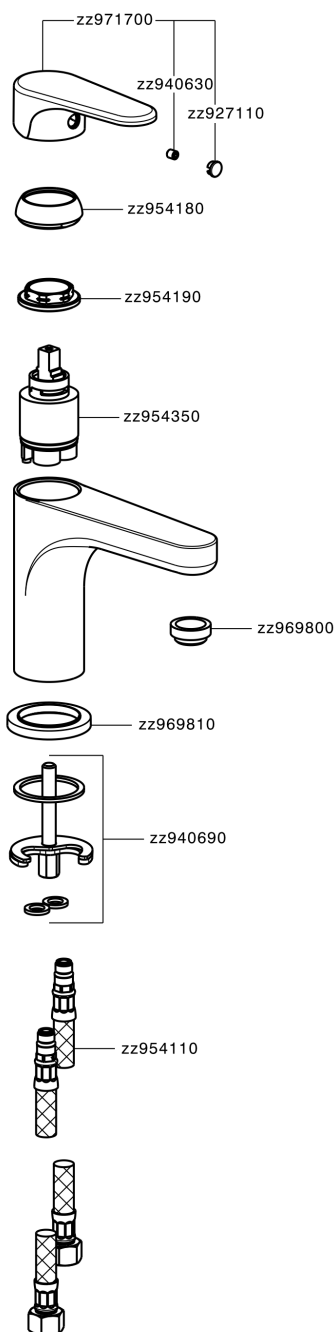

A3000500

<https://en.cisal.it/single-lever-large-washbasin-mixer-alma-a3000500>

2026-04-30