





## Exposed part for concealed washbasin mixer **CHERIE\_CX013510**

MODEL **CX013510**

Exposed part for concealed washbasin mixer, without concealed part, for item ZA033510

### AVAILABLE FINISHINGS

- 
**6T** 6T Chrome/Matt Black
- 
**7C** 7C Gold/Matt Black
- 
**7D** 7D Polished Nickel/Matt Black
- 
**7E** 7E Rose Gold/Matt Black

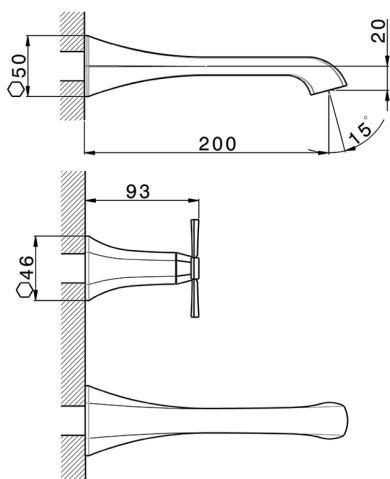
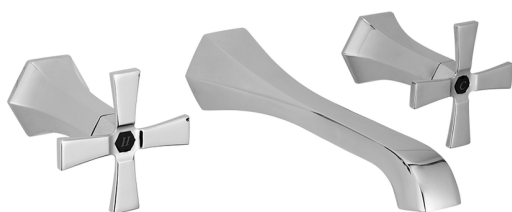

### CHARACTERISTICS

Installation **Concealed**  
 Required concealed parts **ZA033510**



## Exposed part for concealed washbasin mixer CHERIE\_CX013510

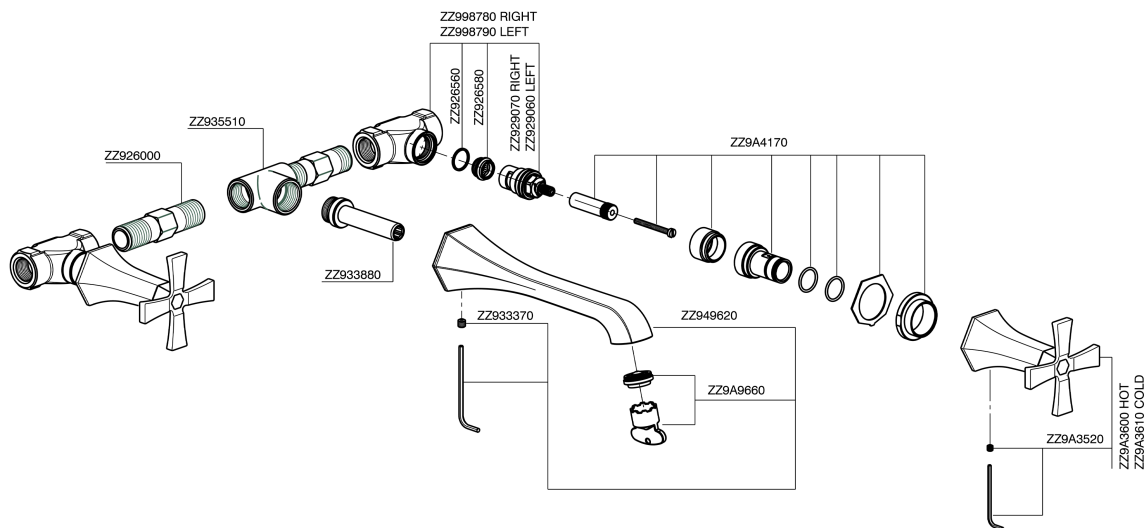

CX013510

<https://en.cisal.it/exposed-part-for-concealed-washbasin-mixer-cherie-cx013510>

## Concealed washbasin mixer CONCEALED\_ZA033510

MODEL **ZA033510**

Concealed washbasin mixer, with two right headvalves

AVAILABLE FINISHINGS

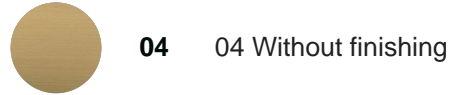

CHARACTERISTICS

Concealed **1**

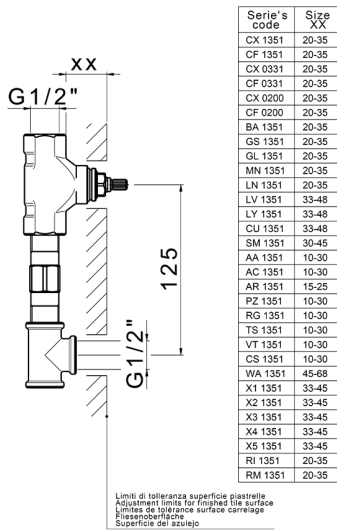

2026-06-14