

Concealed stop valve TR_TR000301

MODEL **TR000301**

Concealed stop valve, G.3/4" outlet, without handles

AVAILABLE FINISHINGS



CHARACTERISTICS

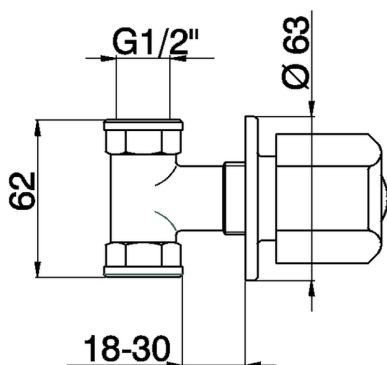

2024-12-22