





## Exposed part for con.thermo.shower valve, 3-outlet SLIM\_SM018200

MODEL **SM018200**

Exposed part for con.thermo.shower valve,  
3-outlet,with 3 outlet deviastop,without concealed  
part,for item ZA018201

### AVAILABLE FINISHINGS

-  **21** 21 Chrome
-  **2B** 2B Polished Nickel
-  **40** 40 Matt Black
-  **4Q** 4Q Matt White

### CHARACTERISTICS

Installation **Concealed**  
Required concealed parts **ZA018201**

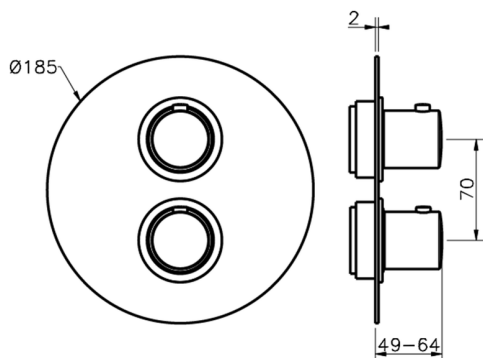

### Thermostatic

The Cisal thermostatic is your personal water manager, helping you to handle, control and save water and energy.



## Concealed thermostatic shower valve, 3-outlets CONCEALED\_ZA018201

MODEL **ZA018201**

Concealed thermostatic shower valve, 3-outlets, with 1/2" 3 outlet deviastop cartridge, without trim kit



AVAILABLE FINISHINGS



**04** 04 Without finishing

CHARACTERISTICS

Concealed **1**  
Cartridge Spare Parts **24.04A.PP**

**8x20 Plus P Thermostatic Valve**

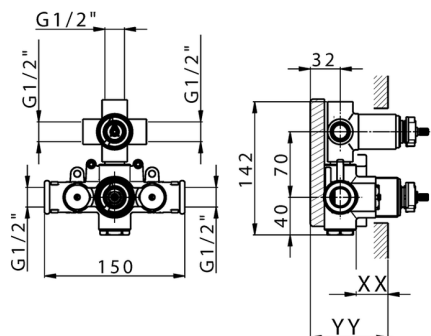

Piastra/Plate/Plaque/Platte/Placa  
2-3mm: XX 25-40 YY 76-91  
10 mm: XX 16-31 YY 65-80



### DeviaStop

The Cisal Devia Stop technology allows to adjust the water flow and to direct it to the selected output point (overhead soaker, hand shower, etc).



### Thermostatic

The Cisal thermostatic is your personal water manager, helping you to handle, control and save water and energy.



2026-04-26