

Cover Part for 2 Function Concealed Thermo Valve ROADSTER ACCENT_RA01R200

RA01R200

<https://en.cisal.it/cover-part-for-2-function-concealed-thermo-valve-roadster-accent-ra01r200>

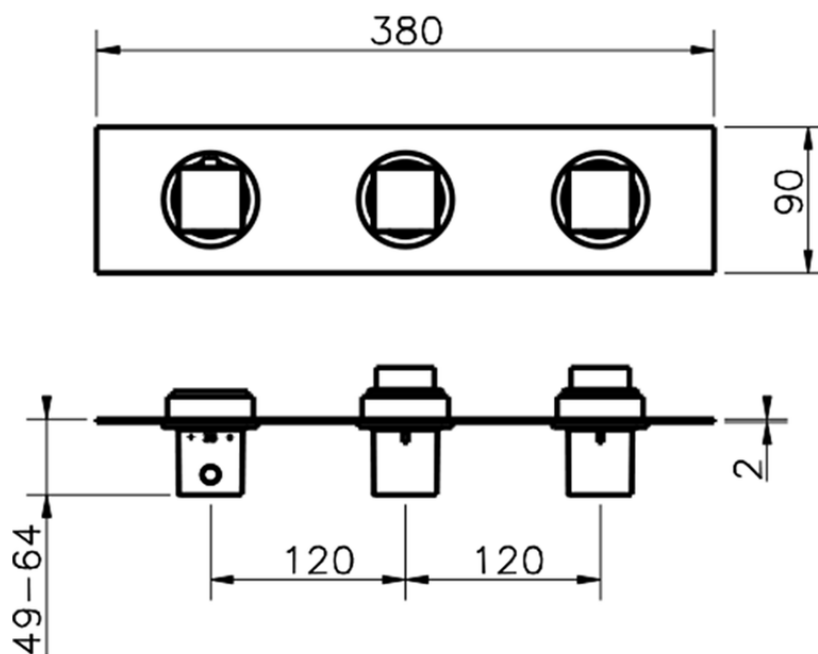
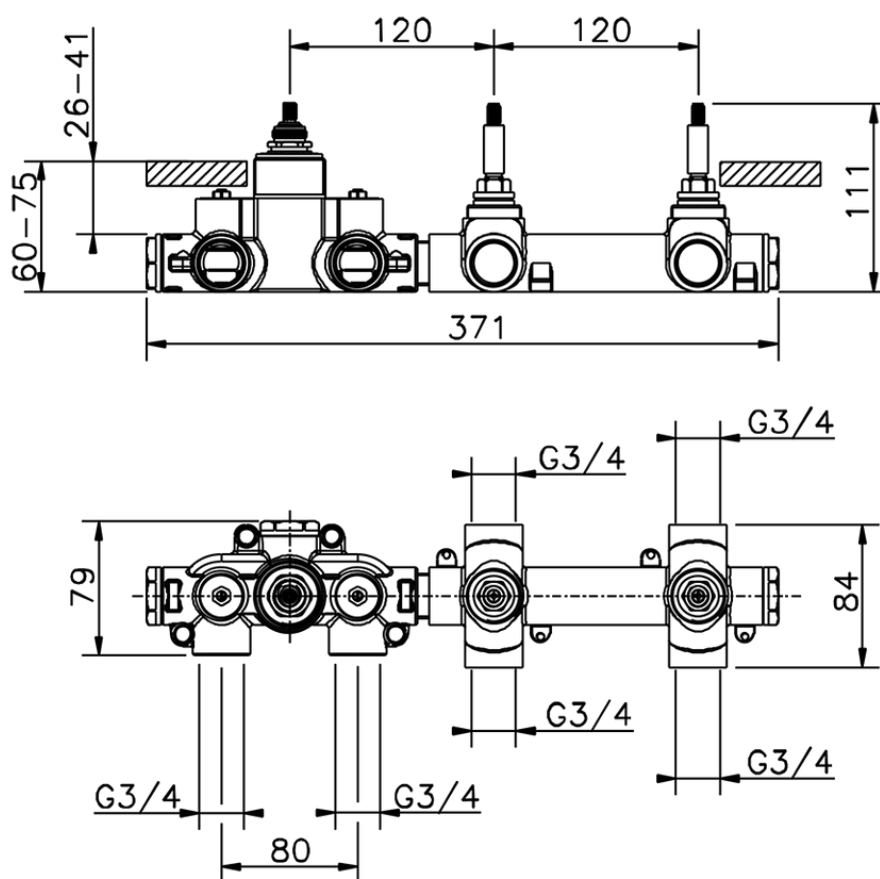

ZA01R200

<https://en.cisal.it/2-function-concealed-thermostatic-valve-concealed-za01r200>

2026-05-19