

Stopvalve exposed part GRACE_MN003310

MODEL **MN003310**

Stopvalve exposed part, without concealed part, for item ZA003330-ZA003340



AVAILABLE FINISHINGS

-  **21** 21 Chrome
-  **2F** 2F Brushed Nickel
-  **2W** 2W Brushed Gold
-  **5H** 5H Dark Brass Brushed
-  **5L** 5L Brushed Black Titanium
-  **6T** 6T Chrome/Matt Black

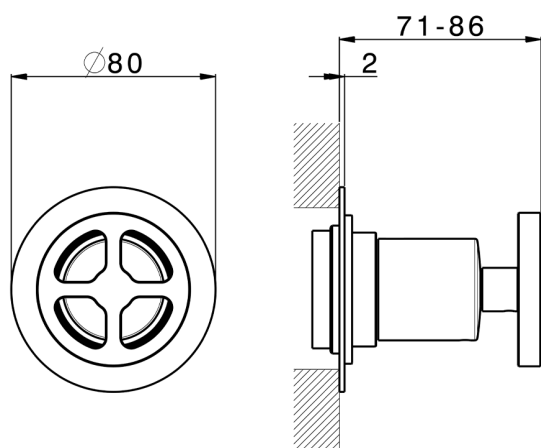

CHARACTERISTICS

Installation **Concealed**

Required concealed parts **ZA003340**

ZA003330



1/2 Stopvalve concealed part CONCEALED_ZA003340

MODEL **ZA003340**

1/2" Stopvalve concealed part, opening counterclockwise



AVAILABLE FINISHINGS

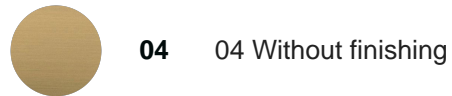

CHARACTERISTICS

Concealed **1**

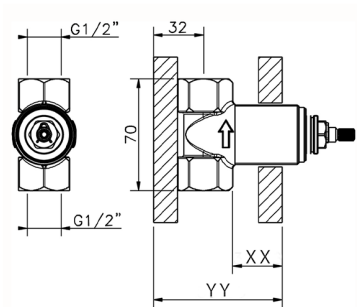

Piastra/Plate/Plaque/Platte/Placa
 2-3mm: XX 31-46 YY 80-95
 10mm: XX 25-40 YY 76-91



3/4 Stopvalve concealed part CONCEALED_ZA003330

MODEL **ZA003330**

3/4" Stopvalve concealed part, opening counterclockwise



AVAILABLE FINISHINGS



04 04 Without finishing

CHARACTERISTICS

Concealed **1**

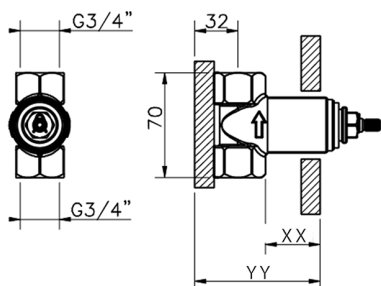

Piastra/Plate/Plaque/Platte/Placa

2-3mm: XX 31-46 YY 80-95

10mm: XX 25-40 YY 76-91



2025-01-02