

Exposed part for Thermostatic One Box Valve ROCK&ROLL_RK0BT030

RK0BT030

<https://en.cisal.it/exposed-part-for-thermostatic-one-box-valve-rockroll-rk0bt030>

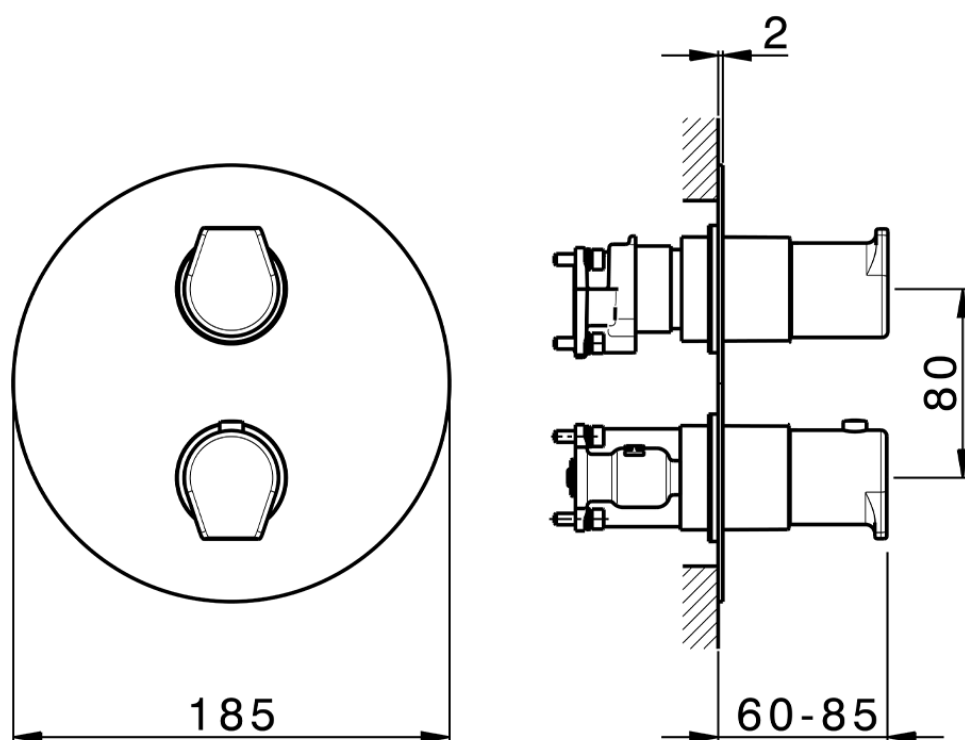

ZA00B031

<https://en.cisal.it/one-box-universal-concealed-part-one-box-za00b031>



ZA00B030

<https://en.cisal.it/one-box-universal-concealed-part-one-box-za00b030>

2026-04-16