

## Exposed part for con.thermo.shower valve, 2-outlet LESS MINIMAL\_LN018100

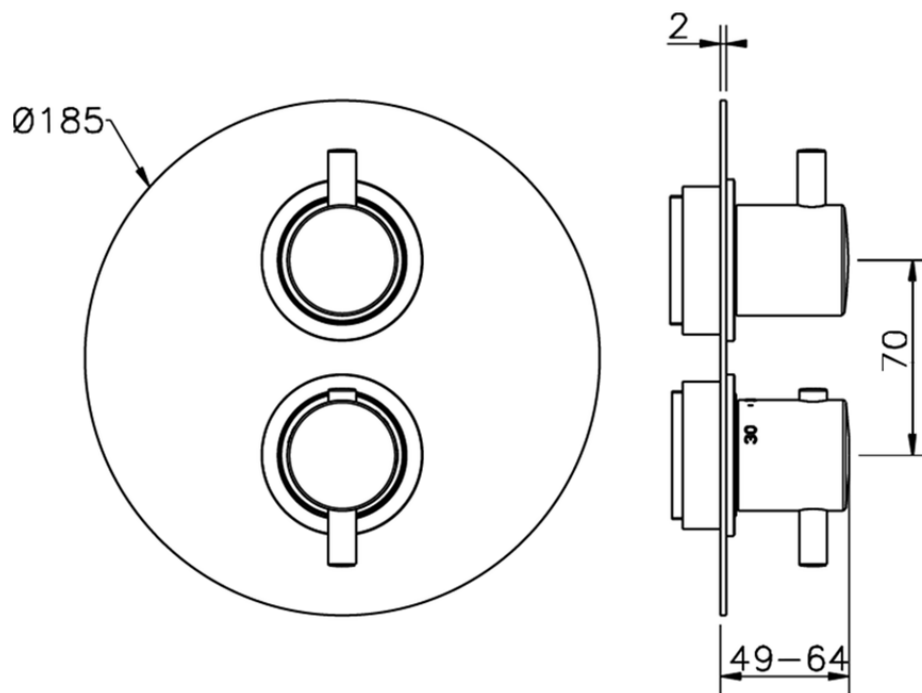

LN018100

<https://en.cisal.it/exposed-part-for-con-thermo-shower-valve-2-outlet-less-minimal-ln018100>



## Piastra/Plate/Plaque/Platte/Placa

2-3mm: XX 25-40 YY 76-91

10 mm: XX 16-31 YY 65-80

ZA018101

<https://en.cisal.it/concealed-thermostatic-shower-valve-2-outlets-concealed-za018101>

2026-04-24