

Free Standing Progressive Shower Column WELLNESS_XI005120

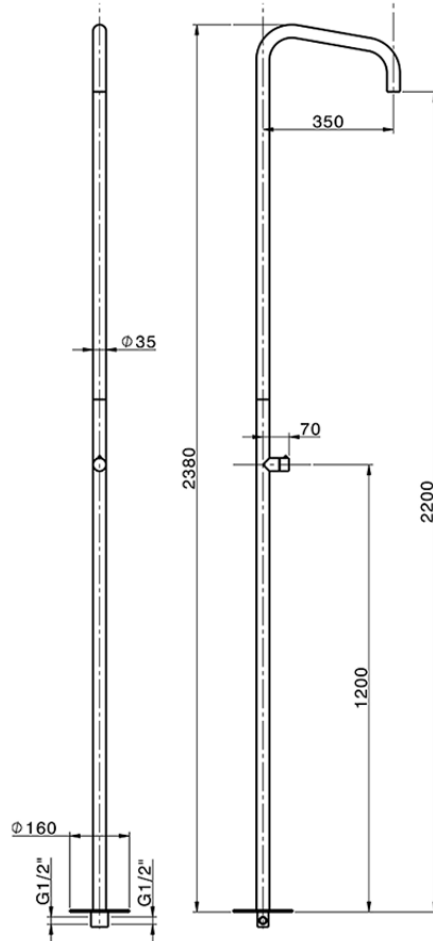

XI005120

<https://en.cisal.it/free-standing-progressive-shower-column-wellness-xi005120>

2026-05-20