

## 1 1/4 waste for basin mixer COMPONENTS\_ZA001610

MODEL **ZA001610**

1" 1/4 waste for basin mixer, always open, for bath drain system without overflow, for thickness max 50 mm



### AVAILABLE FINISHINGS

-  **21** 21 Chrome
-  **24** 24 Gold
-  **2A** 2A Satin Brushed Nickel
-  **2B** 2B Polished Nickel
-  **2P** 2P Rose Gold

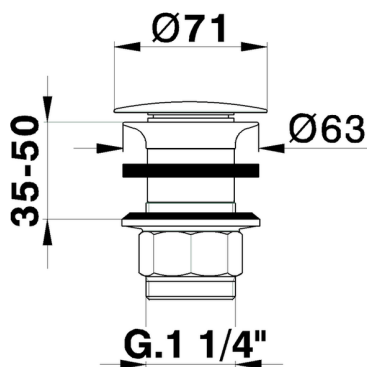

### CHARACTERISTICS



2026-06-16