

## Single lever shower mixer, with shower set SLIM\_SM000460

MODEL **SM000460**

Single lever shower mixer, with shower set, 60 cm slide rail kit with sliding bracket, Brass minimalistic one spray handshower, 150 cm SUPREME smooth flexible hose



### AVAILABLE FINISHINGS

-  **21** 21 Chrome
-  **2B** 2B Polished Nickel
-  **40** 40 Matt Black
-  **4Q** 4Q Matt White

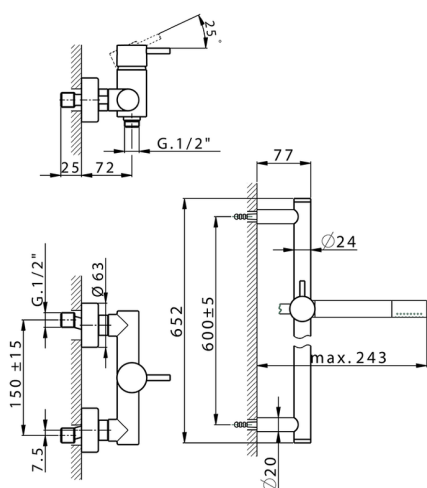

### CHARACTERISTICS

Cartridge Spare Parts **ZZ95409000**

**35 mm Cartridge**



### EcoStop

EcoStop feature limits water flow to approximately 50% of maximum output with one point of resistance on setting. Push slightly past the middle stop only when full water output is required. This will save water up to 50%.



2026-04-26