

## Exposed part for Single Lever One Box Valve ONE BOX\_EM0BM010

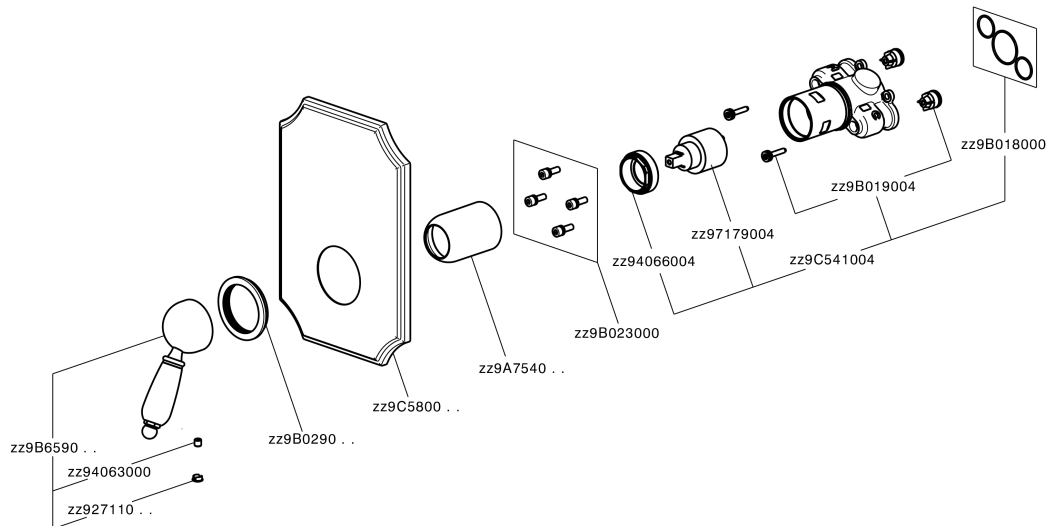

EM0BM010

<https://en.cisal.it/exposed-part-for-single-lever-one-box-valve-one-box-em0bm010>

## One Box Universal Concealed Part ONE BOX\_ZA00B031



ZA00B031

<https://en.cisal.it/one-box-universal-concealed-part-one-box-za00b031>

## One Box Universal Concealed Part ONE BOX\_ZA00B030



ZA00B030

<https://en.cisal.it/one-box-universal-concealed-part-one-box-za00b030>

2026-04-05