

## Exposed part for con.thermo.shower valve, 3-outlet TENDER\_C2018200

MODEL **C2018200**

Exposed part for con.thermo.shower valve,  
3-outlet,with 3 outlet deviastop,without concealed  
part,for item ZA018201



AVAILABLE FINISHINGS



CHARACTERISTICS

Installation **Concealed**

Required concealed parts **ZA018201**

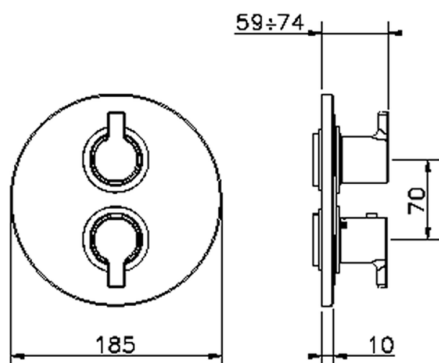

### Thermostatic

The Cisal thermostatic is your personal water manager, helping you to handle, control and save water and energy.



## Concealed thermostatic shower valve, 3-outlets CONCEALED\_ZA018201

MODEL **ZA018201**

Concealed thermostatic shower valve, 3-outlets, with 1/2" 3 outlet devia-stop cartridge, without trim kit



AVAILABLE FINISHINGS

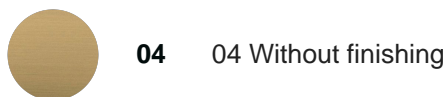

CHARACTERISTICS

Concealed **1**  
 Cartridge Spare Parts **24.04A.PP**  
**8x20 Plus P Thermostatic Valve**

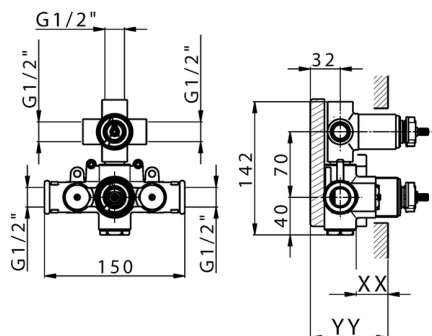

Piastra/Plate/Plaque/Platte/Placa  
 2-3mm: XX 25-40 YY 76-91  
 10 mm: XX 16-31 YY 65-80



### DeviaStop

The Cisal Devia Stop technology allows to adjust the water flow and to direct it to the selected output point (overhead soaker, hand shower, etc).



### Thermostatic

The Cisal thermostatic is your personal water manager, helping you to handle, control and save water and energy.



2026-04-25