

## Cover Part for 3 Function Concealed Thermo Valve WELLNESS\_RI01V300

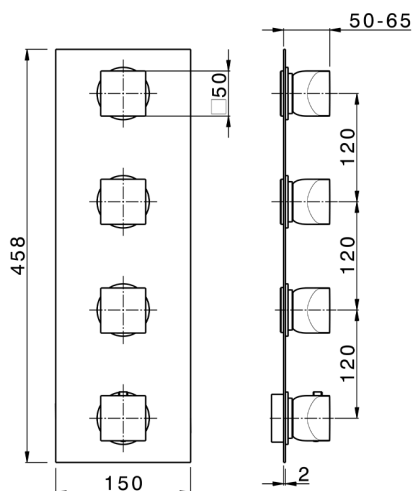

MODEL **RI01V300**

Cover Part for 3 Function Concealed Thermo Valve, for item ZA01V300

### AVAILABLE FINISHINGS

-  **21** 21 Chrome
-  **24** 24 Gold
-  **2F** 2F Brushed Nickel
-  **2W** 2W Brushed Gold
-  **40** 40 Matt Black
-  **4Q** 4Q Matt White
-  **5G** 5G Rose Gold
-  **6V** 6V Matt White/Brushed Nickel
-  **6X** 6X Matt White/Brushed Gold
-  **7W** 7W Matt Black/Brushed Gold

### CHARACTERISTICS

Installation **Concealed**  
 Required concealed parts **ZA01V300**



### Thermostatic

The Cisal thermostatic is your personal water manager, helping you to handle, control and save water and energy.

## 3 Function Concealed Thermostatic Built-in Part CONCEALED\_ZA01V300

MODEL **ZA01V300**

3 Function Concealed Thermostatic Built-in Part

AVAILABLE FINISHINGS



CHARACTERISTICS

Concealed **1**  
 Cartridge Spare Parts **23.51A.HF**  
**HF Thermostatic Valve**



### Thermostatic

The Cisal thermostatic is your personal water manager, helping you to handle, control and save water and energy.



2026-04-25