

Spout COMPONENTS_ZA001251

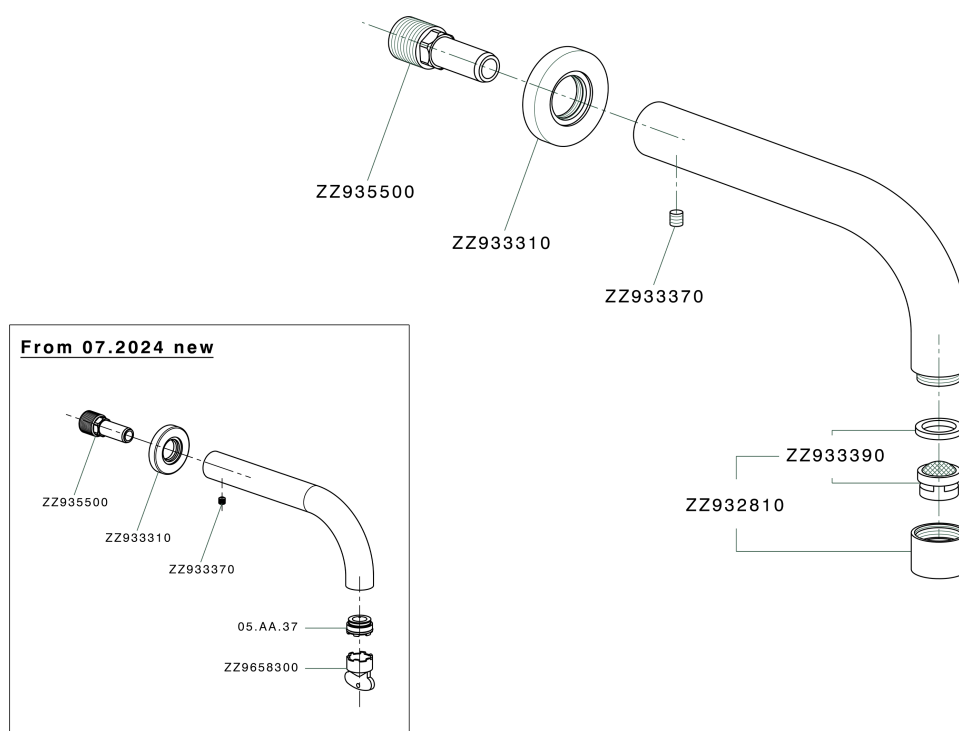

ZA001251

<https://en.cisal.it/spout-components-za001251>

2026-04-29