





Exposed part for Single Lever One Box Valve SMOOTH X32_X30BM010

MODEL **X30BM010**

Exposed part for Single Lever One Box Valve, 1 Outlet - with smooth handle, Minimum depth of installation: 67 mm, without concealed part - Inox AISI 316L, for items ZA00B030-ZA00B031

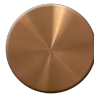
AVAILABLE FINISHINGS

-  **5H** 5H Dark Brass Brushed
-  **5L** 5L Brushed Black Titanium
-  **5N** 5N Brushed Rose Gold
-  **D1** D1 Brushed Inox

CHARACTERISTICS

Cartridge Spare Parts **ZZ97179000**

35 mm Cartridge

Installation **Concealed**

Required concealed parts **ZA00B031**

ZA00B030

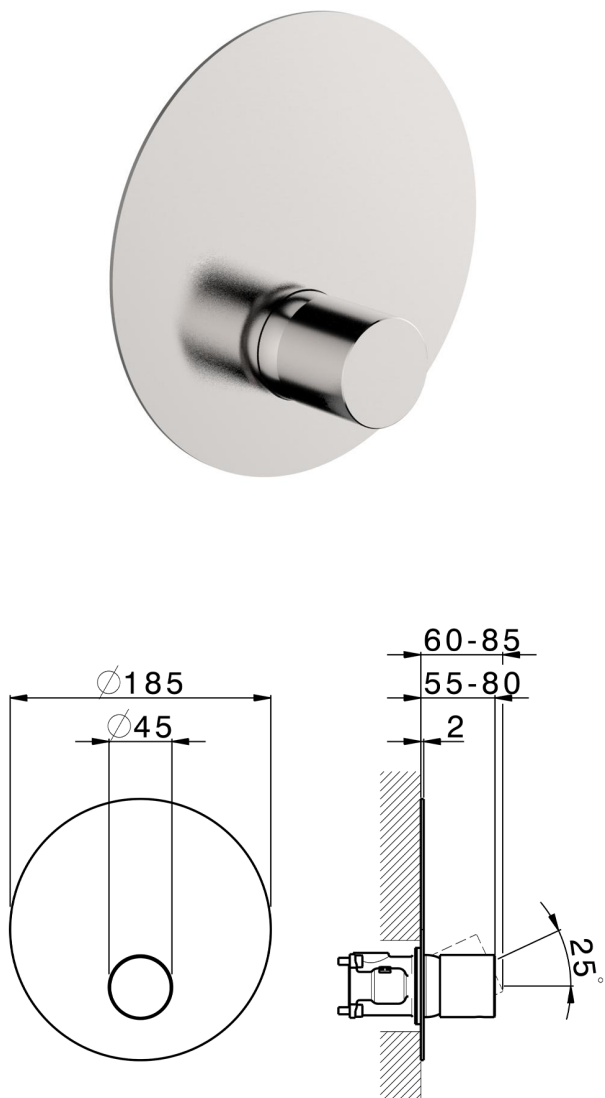

Exposed part for Single Lever One Box Valve SMOOTH X32_X30BM010

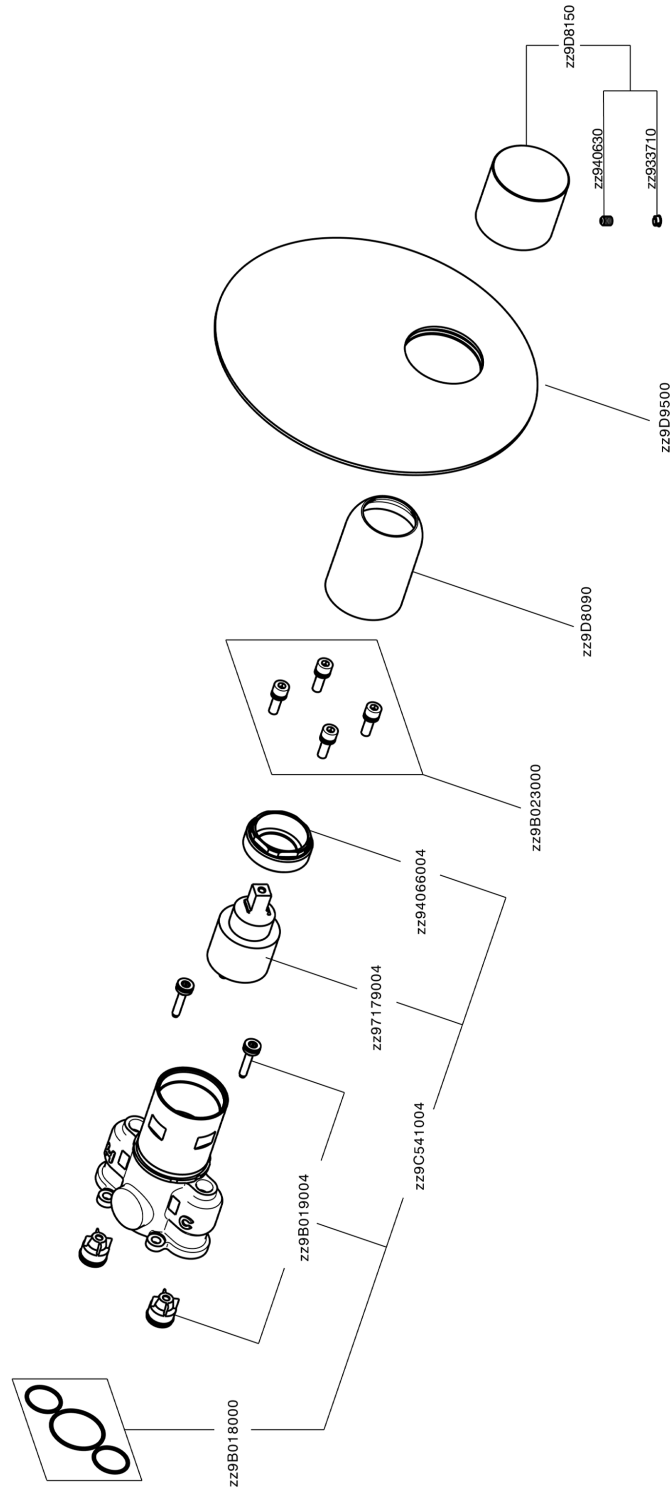

X30BM010

<https://en.cisal.it/exposed-part-for-single-lever-one-box-valve-smooth-x32-x30bm010>

One Box Universal Concealed Part ONE BOX_ZA00B031

MODEL **ZA00B031**

One Box Universal Concealed Part, for 1, 2 or 3 outlet thermostatic or single lever, without trim kit, with noise reducers, with sealing gasket

AVAILABLE FINISHINGS

 **04** 04 Without finishing

CHARACTERISTICS

Concealed **1**



Thermostatic

The Cisal thermostatic is your personal water manager, helping you to handle, control and save water and energy.



One Box Universal Concealed Part ONE BOX_ZA00B030

MODEL **ZA00B030**

One Box Universal Concealed Part, for 1, 2 or 3 outlet thermostatic or single lever, without trim kit, without noise reducers, with sealing gasket

AVAILABLE FINISHINGS

 **04** 04 Without finishing

CHARACTERISTICS

Concealed **1**



Thermostatic

The Cisal thermostatic is your personal water manager, helping you to handle, control and save water and energy.



2025-01-07