

Spout COMPONENTS_ZA003251

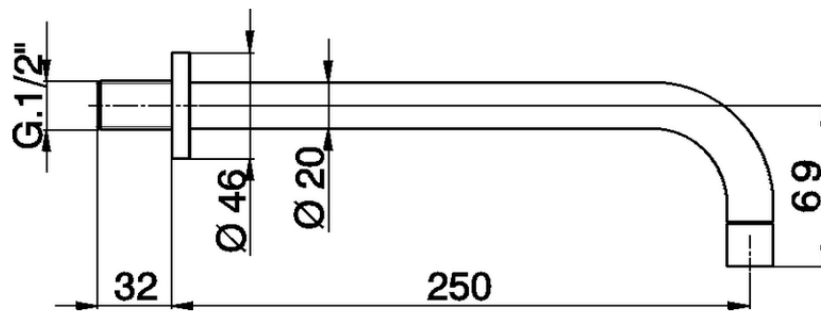

ZA003251

<https://en.cisal.it/spout-components-za003251>

2026-04-08